

Plaqueurs Pitbull®
23290.0056



Description produit

Les plaqueurs Pitbull® sont conçus pour des hauteurs réduites et des forces de serrage élevées et un effet de plaquage. Le joint torique permet de soulever le plaqueur lors du desserrage. The knife edge version (picture 1) is especially suited for blanks. The blunt edged version (picture 2) allows you to cover nearly all types of application. The version made of brass provides for clamping that is gentle, yet secure. The Pitbull® Clamp with machinable edge (picture 3) has been designed with a machining add-on that allows for a contour to be milled into the workpiece. This version from hardened steel combines good machinability with excellent wear resistance. The Pitbull® Clamps are distinguished by the following characteristics:

- space-saving design
- extra low construction height
- high clamping / tensioning force with pull-down effect
- ideal for multi-side machining and multiple clamping systems

Matières

Mini crampon
• acier trempé

Vis
• acier traité

Joint torique
• NBR

Plus d'informations

Notes

The o-ring is used to lift the clamp off when it is released.

Plan

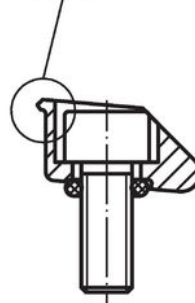
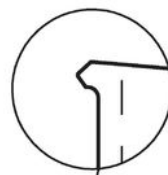
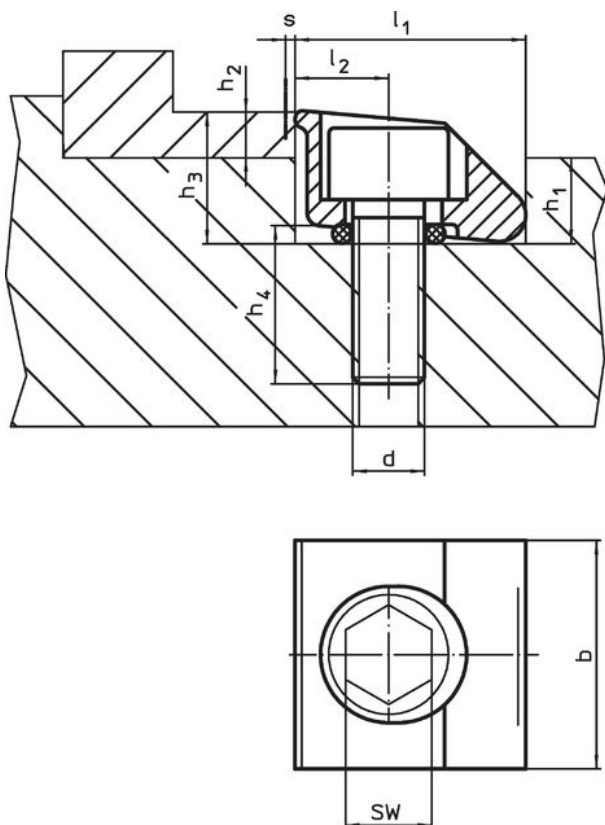

croquis 1

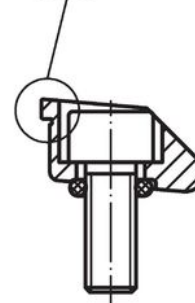
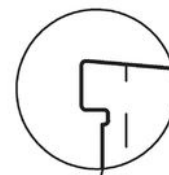

croquis 2

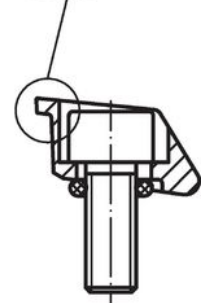
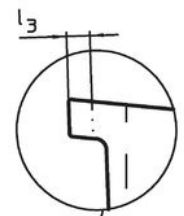

croquis 3

Informations détaillées

d	b	Dimensions						Course de serrage s	SW	Force de serrage max.	Couple de serrage max.	Température		Référence article	
		l_1 H9	l_2	h_1	h_2 min.	h_3 ~	h_4 ~					min.	max.		
[mm]													[°C]	[g]	
à bord pointu – croquis 1, acier															
M10	25,4	25,4	10,2	11,4	6,3	17,8	17	1,2	8	15	40	-30	80	66	23290.0056

Exemple d'application

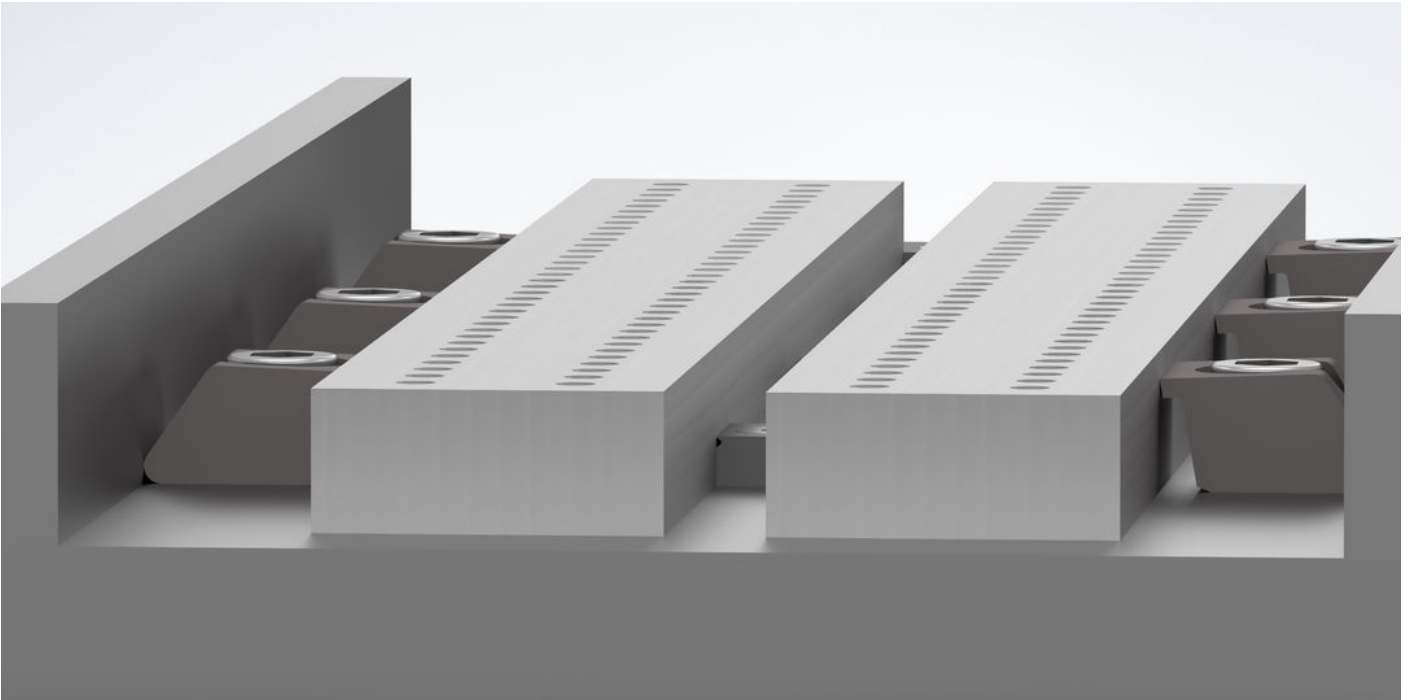

butée
23290.0104

plaqueur Pitbull
p. ex. 23290.0052

griffe de serrage
p. ex. 23290.0101

Conformité

Conforme à la directive RoHS

Conforme à la directive 2011/65/CE et à la directive 2015/863.

Ne contient pas de substances SVHC

Pas de substances SVHC avec une teneur supérieure à 0,1% m/m – Liste SVHC [REACH] au 23.01.2024.

Ne contient pas de substances de la Proposition 65

Aucune des substances de la Proposition 65 présente.

<https://www.P65Warnings.ca.gov/>

Ne contient pas de minerais de la guerre

Ce produit ne contient pas de substances classées comme "minerais de la guerre" telles que le tantale, l'étain, l'or ou le wolfram provenant de République démocratique du Congo ou de pays frontaliers.