

Ball Lock Pins • single acting - comply with NAS / MS17984

EH 4210.



Product Description

Ball Lock Pins according to MS17984 / NAS1333 - 1343 are used for quick fastening, locking, adjusting, changing and securing. Quickly and easily unlockable for frequently repeated connections.

Ball Lock Pins (Quick Release Pins) are produced according to Aviation Norm MS / NAS and tested to NAS 1332.

Surface treatment:

- All stainless steel parts are passivated according AMS2700
- All aluminium parts alloy anodized according MIL-A-8625

Heat treatment:

- Body: Rc. 40 min. (AMS2759, Condition H900)
- Spindle: Rc. 40 min. (AMS2759, Condition H900)
- Ball: Rc. 58-62 min. (AMS2759)

Material

Body

- Stainless steel, precipitation-hardened, passivated - CRES 17-4PH (specification AMS5643)

Spindle

- Stainless steel, precipitation-hardened, passivated - CRES 17-4PH (specification AMS5643)

Spring

- Stainless steel, passivated - CRES 302 (specification ASTM-A-313)

Handle

- Aluminium, black anodised - Alum.Alloy A380 (specification ASTM B85/B85)
- From 3/8" - Aluminium, black anodised - Alum.Alloy 6061-T6 (specification AMS-QQ-A200/8)

Attaching ring

- Stainless steel, passivated - CRES 302 (specification ASTM A-313/A313M)

Press button

- Stainless steel, passivated - CRES 303 (specification ASTM A484/484M)

Ball

- Stainless steel, precipitation-hardened, passivated - CRES 440C (specification AMS5630)

Operation

Ball lock pins single acting are self-locking and require a push of the button to release the balls.

More information

Notes

All further dimensions are available on request.

Other diameter / length combinations not listed which comply with the standard can be produced at short notice on customer request. Special types on request.



- This product is manufactured in INCH dimensions.

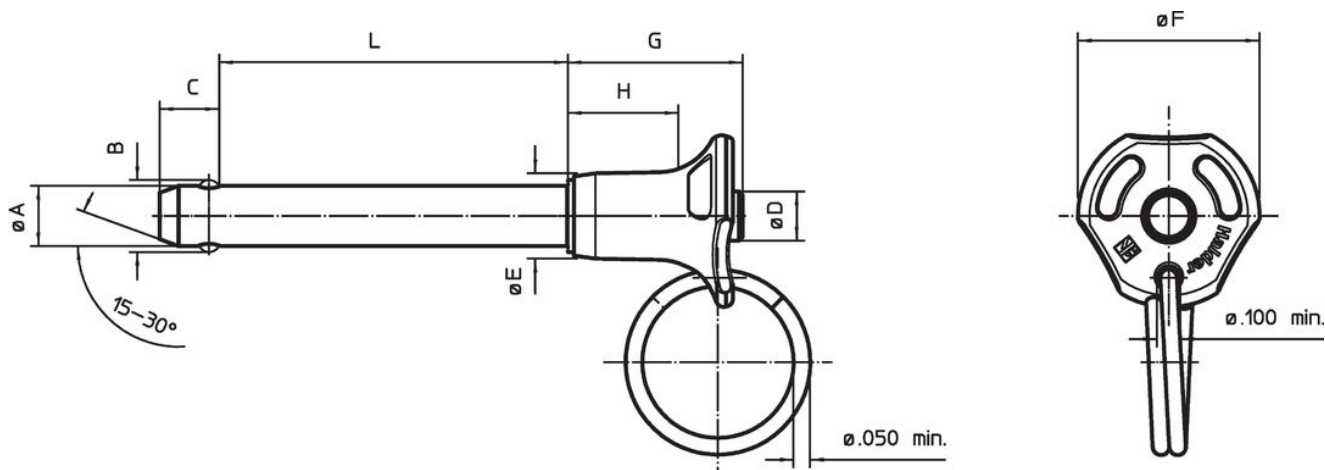

Drawing







Order information



Nominal diameter A	A		Clamping length L +0.02 0	Dimensions							Location hole max.	Shearing resistance, two-shear min.	Temperature		Weight [g]	Standard description	Art. No.
	min.	max.		B ±0.005	C 0 -0.04	D max.	E max.	F max.	G max.	H min.			min.	max.			
[in]	[in]	[in]	[in]	[in]							[in]	[lbf]	[°F]		[g]		
3/16	0.1870	0.1885	0.3	0.220	0.26	0.31	0.44	0.800	0.83	0.48	0.1940	5,150	-65	200	13.1	MS17984C303 / NAS1333A3C03D	4210.A03
3/16	0.1870	0.1885	0.4	0.220	0.26	0.31	0.44	0.800	0.83	0.48	0.1940	5,150	-65	200	13.4	MS17984C304 / NAS1333A3C04D	4210.A04
3/16	0.1870	0.1885	0.5	0.220	0.26	0.31	0.44	0.800	0.83	0.48	0.1940	5,150	-65	200	13.7	MS17984C305 / NAS1333A3C05D	4210.A05
3/16	0.1870	0.1885	0.6	0.220	0.26	0.31	0.44	0.800	0.83	0.48	0.1940	5,150	-65	200	14.1	MS17984C306 / NAS1333A3C06D	4210.A06
3/16	0.1870	0.1885	0.7	0.220	0.26	0.31	0.44	0.800	0.83	0.48	0.1940	5,150	-65	200	14.4	MS17984C307 / NAS1333A3C07D	4210.A07
3/16	0.1870	0.1885	0.8	0.220	0.26	0.31	0.44	0.800	0.83	0.48	0.1940	5,150	-65	200	14.8	MS17984C308 / NAS1333A3C08D	4210.A08
3/16	0.1870	0.1885	1.0	0.220	0.26	0.31	0.44	0.800	0.83	0.48	0.1940	5,150	-65	200	15.4	MS17984C310 / NAS1333A3C10D	4210.A10
3/16	0.1870	0.1885	1.1	0.220	0.26	0.31	0.44	0.800	0.83	0.48	0.1940	5,150	-65	200	15.8	MS17984C311 / NAS1333A3C11D	4210.A11
3/16	0.1870	0.1885	1.2	0.220	0.26	0.31	0.44	0.800	0.83	0.48	0.1940	5,150	-65	200	16.1	MS17984C312 / NAS1333A3C12D	4210.A12
3/16	0.1870	0.1885	1.3	0.220	0.26	0.31	0.44	0.800	0.83	0.48	0.1940	5,150	-65	200	16.5	MS17984C313 / NAS1333A3C13D	4210.A13
3/16	0.1870	0.1885	1.4	0.220	0.26	0.31	0.44	0.800	0.83	0.48	0.1940	5,150	-65	200	16.8	MS17984C314 / NAS1333A3C14D	4210.A14
3/16	0.1870	0.1885	1.5	0.220	0.26	0.31	0.44	0.800	0.83	0.48	0.1940	5,150	-65	200	17.1	MS17984C315 / NAS1333A3C15D	4210.A15
3/16	0.1870	0.1885	1.6	0.220	0.26	0.31	0.44	0.800	0.83	0.48	0.1940	5,150	-65	200	17.5	MS17984C316 / NAS1333A3C16D	4210.A16
3/16	0.1870	0.1885	1.8	0.220	0.26	0.31	0.44	0.800	0.83	0.48	0.1940	5,150	-65	200	18.2	MS17984C318 / NAS1333A3C18D	4210.A18
3/16	0.1870	0.1885	2.0	0.220	0.26	0.31	0.44	0.800	0.83	0.48	0.1940	5,150	-65	200	18.8	MS17984C320 / NAS1333A3C20D	4210.A20
3/16	0.1870	0.1885	2.2	0.220	0.26	0.31	0.44	0.800	0.83	0.48	0.1940	5,150	-65	200	19.5	MS17984C322 / NAS1333A3C22D	4210.A22
3/16	0.1870	0.1885	2.8	0.220	0.26	0.31	0.44	0.800	0.83	0.48	0.1940	5,150	-65	200	21.6	MS17984C328 / NAS1333A3C28D	4210.A28
3/16	0.1870	0.1885	3.0	0.220	0.26	0.31	0.44	0.800	0.83	0.48	0.1940	5,150	-65	200	22.2	MS17984C330 / NAS1333A3C30D	4210.A30
3/16	0.1870	0.1885	4.3	0.220	0.26	0.31	0.44	0.800	0.83	0.48	0.1940	5,150	-65	200	27.0	MS17984C343 / NAS1333A3C43D	4210.A43
1/4	0.2470	0.2485	0.4	0.289	0.29	0.31	0.44	0.800	0.89	0.48	0.2540	9,200	-65	200	14.8	MS17984C403 / NAS1334A3C03D	4210.B03
1/4	0.2470	0.2485	0.4	0.289	0.29	0.31	0.44	0.800	0.89	0.48	0.2540	9,200	-65	200	15.5	MS17984C404 / NAS1334A3C04D	4210.B04
1/4	0.2470	0.2485	0.5	0.289	0.29	0.31	0.44	0.800	0.89	0.48	0.2540	9,200	-65	200	16.1	MS17984C405 / NAS1334A3C05D	4210.B05
1/4	0.2470	0.2485	0.6	0.289	0.29	0.31	0.44	0.800	0.89	0.48	0.2540	9,200	-65	200	16.7	MS17984C406 / NAS1334A3C06D	4210.B06
1/4	0.2470	0.2485	0.7	0.289	0.29	0.31	0.44	0.800	0.89	0.48	0.2540	9,200	-65	200	17.3	MS17984C407 / NAS1334A3C07D	4210.B07
1/4	0.2470	0.2485	0.8	0.289	0.29	0.31	0.44	0.800	0.89	0.48	0.2540	9,200	-65	200	17.9	MS17984C408 / NAS1334A3C08D	4210.B08
1/4	0.2470	0.2485	0.9	0.289	0.29	0.31	0.44	0.800	0.89	0.48	0.2540	9,200	-65	200	18.5	MS17984C409 / NAS1334A3C09D	4210.B09
1/4	0.2470	0.2485	1.0	0.289	0.29	0.31	0.44	0.800	0.89	0.48	0.2540	9,200	-65	200	19.1	MS17984C410 / NAS1334A3C10D	4210.B10
1/4	0.2470	0.2485	1.1	0.289	0.29	0.31	0.44	0.800	0.89	0.48	0.2540	9,200	-65	200	19.8	MS17984C411 / NAS1334A3C11D	4210.B11
1/4	0.2470	0.2485	1.2	0.289	0.29	0.31	0.44	0.800	0.89	0.48	0.2540	9,200	-65	200	20.4	MS17984C412 / NAS1334A3C12D	4210.B12
1/4	0.2470	0.2485	1.3	0.289	0.29	0.31	0.44	0.800	0.89	0.48	0.2540	9,200	-65	200	21.0	MS17984C413 / NAS1334A3C13D	4210.B13

Nominal diameter A	A min.	A max.	Clamping length L +0.02 0	Dimensions							Location hole max.	Shearing resistance, two-shear min.				Standard description	Art. No.
				B ±0.005	C 0 -0.04	D max.	E max.	F max.	G max.	H min.			min.	max.			
[in]	[in]	[in]	[in]	[in]							[in]	[lbf]	[°F]		[g]		
1/4	0.2470	0.2485	1.4	0.289	0.29	0.31	0.44	0.800	0.89	0.48	0.2540	9,200	-65	200	21.6	MS17984C414 / NAS1334A3C14D	4210.B14
1/4	0.2470	0.2485	1.5	0.289	0.29	0.31	0.44	0.800	0.89	0.48	0.2540	9,200	-65	200	22.2	MS17984C415 / NAS1334A3C15D	4210.B15
1/4	0.2470	0.2485	1.6	0.289	0.29	0.31	0.44	0.800	0.89	0.48	0.2540	9,200	-65	200	22.8	MS17984C416 / NAS1334A3C16D	4210.B16
1/4	0.2470	0.2485	1.7	0.289	0.29	0.31	0.44	0.800	0.89	0.48	0.2540	9,200	-65	200	23.4	MS17984C417 / NAS1334A3C17D	4210.B17
1/4	0.2470	0.2485	1.8	0.289	0.29	0.31	0.44	0.800	0.89	0.48	0.2540	9,200	-65	200	24.1	MS17984C418 / NAS1334A3C18D	4210.B18
1/4	0.2470	0.2485	1.9	0.289	0.29	0.31	0.44	0.800	0.89	0.48	0.2540	9,200	-65	200	24.7	MS17984C419 / NAS1334A3C19D	4210.B19
1/4	0.2470	0.2485	2.0	0.289	0.29	0.31	0.44	0.800	0.89	0.48	0.2540	9,200	-65	200	25.3	MS17984C420 / NAS1334A3C20D	4210.B20
1/4	0.2470	0.2485	2.1	0.289	0.29	0.31	0.44	0.800	0.89	0.48	0.2540	9,200	-65	200	25.9	MS17984C421 / NAS1334A3C21D	4210.B21
1/4	0.2470	0.2485	2.2	0.289	0.29	0.31	0.44	0.800	0.89	0.48	0.2540	9,200	-65	200	26.5	MS17984C422 / NAS1334A3C22D	4210.B22
1/4	0.2470	0.2485	2.3	0.289	0.29	0.31	0.44	0.800	0.89	0.48	0.2540	9,200	-65	200	27.1	MS17984C423 / NAS1334A3C23D	4210.B23
1/4	0.2470	0.2485	2.4	0.289	0.29	0.31	0.44	0.800	0.89	0.48	0.2540	9,200	-65	200	27.7	MS17984C424 / NAS1334A3C24D	4210.B24
1/4	0.2470	0.2485	2.5	0.289	0.29	0.31	0.44	0.800	0.89	0.48	0.2540	9,200	-65	200	28.4	MS17984C425 / NAS1334A3C25D	4210.B25
1/4	0.2470	0.2485	2.6	0.289	0.29	0.31	0.44	0.800	0.89	0.48	0.2540	9,200	-65	200	29.0	MS17984C426 / NAS1334A3C26D	4210.B26
1/4	0.2470	0.2485	2.8	0.289	0.29	0.31	0.44	0.800	0.89	0.48	0.2540	9,200	-65	200	30.2	MS17984C428 / NAS1334A3C28D	4210.B28
1/4	0.2470	0.2485	2.9	0.289	0.29	0.31	0.44	0.800	0.89	0.48	0.2540	9,200	-65	200	30.8	MS17984C429 / NAS1334A3C29D	4210.B29
1/4	0.2470	0.2485	3.1	0.289	0.29	0.31	0.44	0.800	0.89	0.48	0.2540	9,200	-65	200	32.0	MS17984C431 / NAS1334A3C31D	4210.B31
1/4	0.2470	0.2485	3.3	0.289	0.29	0.31	0.44	0.800	0.89	0.48	0.2540	9,200	-65	200	33.3	MS17984C433 / NAS1334A3C33D	4210.B33
1/4	0.2470	0.2485	3.5	0.289	0.29	0.31	0.44	0.800	0.89	0.48	0.2540	9,200	-65	200	34.5	MS17984C435 / NAS1334A3C35D	4210.B35
1/4	0.2470	0.2485	4.2	0.289	0.29	0.31	0.44	0.800	0.89	0.48	0.2540	9,200	-65	200	38.8	MS17984C442 / NAS1334A3C42D	4210.B42
1/4	0.2470	0.2485	4.5	0.289	0.29	0.31	0.44	0.800	0.89	0.48	0.2540	9,200	-65	200	40.6	MS17984C445 / NAS1334A3C45D	4210.B45
1/4	0.2470	0.2485	5.0	0.289	0.29	0.31	0.44	0.800	0.89	0.48	0.2540	9,200	-65	200	43.7	MS17984C450 / NAS1334A3C50D	4210.B50
1/4	0.2470	0.2485	5.4	0.289	0.29	0.31	0.44	0.800	0.89	0.48	0.2540	9,200	-65	200	46.2	MS17984C454 / NAS1334A3C54D	4210.B54
5/16	0.3095	0.3110	0.3	0.375	0.33	0.31	0.49	1.135	0.93	0.48	0.3165	14,400	-65	200	18.7	MS17984C503 / NAS1335A3C03D	4210.C03
5/16	0.3095	0.3110	0.5	0.375	0.33	0.31	0.49	1.135	0.93	0.48	0.3165	14,400	-65	200	20.6	MS17984C505 / NAS1335A3C05D	4210.C05
5/16	0.3095	0.3110	0.6	0.375	0.33	0.31	0.49	1.135	0.93	0.48	0.3165	14,400	-65	200	21.6	MS17984C506 / NAS1335A3C06D	4210.C06
5/16	0.3095	0.3110	0.7	0.375	0.33	0.31	0.49	1.135	0.93	0.48	0.3165	14,400	-65	200	22.5	MS17984C507 / NAS1335A3C07D	4210.C07
5/16	0.3095	0.3110	0.8	0.375	0.33	0.31	0.49	1.135	0.93	0.48	0.3165	14,400	-65	200	23.4	MS17984C508 / NAS1335A3C08D	4210.C08
5/16	0.3095	0.3110	0.9	0.375	0.33	0.31	0.49	1.135	0.93	0.48	0.3165	14,400	-65	200	24.0	MS17984C509 / NAS1335A3C09D	4210.C09
5/16	0.3095	0.3110	1.0	0.375	0.33	0.31	0.49	1.135	0.93	0.48	0.3165	14,400	-65	200	25.3	MS17984C510 / NAS1335A3C10D	4210.C10
5/16	0.3095	0.3110	1.2	0.375	0.33	0.31	0.49	1.135	0.93	0.48	0.3165	14,400	-65	200	27.2	MS17984C512 / NAS1335A3C12D	4210.C12
5/16	0.3095	0.3110	1.3	0.375	0.33	0.31	0.49	1.135	0.93	0.48	0.3165	14,400	-65	200	28.2	MS17984C513 / NAS1335A3C13D	4210.C13
5/16	0.3095	0.3110	1.4	0.375	0.33	0.31	0.49	1.135	0.93	0.48	0.3165	14,400	-65	200	29.1	MS17984C514 / NAS1335A3C14D	4210.C14

Nominal diameter A	A min.	A max.	Clamping length L +0.02 0	Dimensions							Location hole max.	Shearing resistance, two-shear min.				Standard description	Art. No.
				B ±0.005	C 0 -0.04	D max.	E max.	F max.	G max.	H min.			min.	max.			
[in]	[in]	[in]	[in]	[in]							[in]	[lbf]	[°F]		[g]		
5/16	0.3095	0.3110	1.5	0.375	0.33	0.31	0.49	1.135	0.93	0.48	0.3165	14,400	-65	200	30.1	MS17984C515 / NAS1335A3C15D	4210.C15
5/16	0.3095	0.3110	1.6	0.375	0.33	0.31	0.49	1.135	0.93	0.48	0.3165	14,400	-65	200	31.0	MS17984C516 / NAS1335A3C16D	4210.C16
5/16	0.3095	0.3110	1.7	0.375	0.33	0.31	0.49	1.135	0.93	0.48	0.3165	14,400	-65	200	32.0	MS17984C517 / NAS1335A3C17D	4210.C17
5/16	0.3095	0.3110	1.8	0.375	0.33	0.31	0.49	1.135	0.93	0.48	0.3165	14,400	-65	200	32.9	MS17984C518 / NAS1335A3C18D	4210.C18
5/16	0.3095	0.3110	1.9	0.375	0.33	0.31	0.49	1.135	0.93	0.48	0.3165	14,400	-65	200	33.8	MS17984C519 / NAS1335A3C19D	4210.C19
5/16	0.3095	0.3110	2.0	0.375	0.33	0.31	0.49	1.135	0.93	0.48	0.3165	14,400	-65	200	34.8	MS17984C520 / NAS1335A3C20D	4210.C20
5/16	0.3095	0.3110	2.1	0.375	0.33	0.31	0.49	1.135	0.93	0.48	0.3165	14,400	-65	200	35.8	MS17984C521 / NAS1335A3C21D	4210.C21
5/16	0.3095	0.3110	2.2	0.375	0.33	0.31	0.49	1.135	0.93	0.48	0.3165	14,400	-65	200	36.7	MS17984C522 / NAS1335A3C22D	4210.C22
5/16	0.3095	0.3110	2.3	0.375	0.33	0.31	0.49	1.135	0.93	0.48	0.3165	14,400	-65	200	37.6	MS17984C523 / NAS1335A3C23D	4210.C23
5/16	0.3095	0.3110	2.5	0.375	0.33	0.31	0.49	1.135	0.93	0.48	0.3165	14,400	-65	200	39.6	MS17984C525 / NAS1335A3C25D	4210.C25
5/16	0.3095	0.3110	2.6	0.375	0.33	0.31	0.49	1.135	0.93	0.48	0.3165	14,400	-65	200	40.5	MS17984C526 / NAS1335A3C26D	4210.C26
5/16	0.3095	0.3110	2.7	0.375	0.33	0.31	0.49	1.135	0.93	0.48	0.3165	14,400	-65	200	41.4	MS17984C527 / NAS1335A3C27D	4210.C27
5/16	0.3095	0.3110	2.9	0.375	0.33	0.31	0.49	1.135	0.93	0.48	0.3165	14,400	-65	200	43.3	MS17985C529 / NAS1335A3C29D	4210.C29
5/16	0.3095	0.3110	3.0	0.375	0.33	0.31	0.49	1.135	0.93	0.48	0.3165	14,400	-65	200	44.3	MS17984C530 / NAS1335A3C30D	4210.C30
5/16	0.3095	0.3110	3.2	0.375	0.33	0.31	0.49	1.135	0.93	0.48	0.3165	14,400	-65	200	46.2	MS17984C532 / NAS1335A3C32D	4210.C32
5/16	0.3095	0.3110	3.4	0.375	0.33	0.31	0.49	1.135	0.93	0.48	0.3165	14,400	-65	200	48.0	MS17984C534 / NAS1335A3C34D	4210.C34
5/16	0.3095	0.3110	3.5	0.375	0.33	0.31	0.49	1.135	0.93	0.48	0.3165	14,400	-65	200	49.0	MS17984C535 / NAS1335A3C35D	4210.C35
5/16	0.3095	0.3110	3.6	0.375	0.33	0.31	0.49	1.135	0.93	0.48	0.3165	14,400	-65	200	50.0	MS17984C536 / NAS1335A3C36D	4210.C36
5/16	0.3095	0.3110	3.7	0.375	0.33	0.31	0.49	1.135	0.93	0.48	0.3165	14,400	-65	200	50.9	MS17984C537 / NAS1335A3C37D	4210.C37
5/16	0.3095	0.3110	3.8	0.375	0.33	0.31	0.49	1.135	0.93	0.48	0.3165	14,400	-65	200	51.8	MS17984C538 / NAS1335A3C38D	4210.C38
5/16	0.3095	0.3110	4.9	0.375	0.33	0.31	0.49	1.135	0.93	0.48	0.3165	14,400	-65	200	54.7	MS17984C541 / NAS1335A3C41D	4210.C41
5/16	0.3095	0.3110	4.9	0.375	0.33	0.31	0.49	1.135	0.93	0.48	0.3165	14,400	-65	200	62.3	MS17984C549 / NAS1335A3C49D	4210.C49
5/16	0.3095	0.3110	5.0	0.375	0.33	0.31	0.49	1.135	0.93	0.48	0.3165	14,400	-65	200	63.2	MS17984C550 / NAS1335A3C50D	4210.C50
3/8	0.3720	0.3735	0.3	0.440	0.36	0.39	0.57	1.135	1.04	0.62	0.3790	20,700	-65	200	26.4	MS17984C603 / NAS1336A3C03D	4210.D03
3/8	0.3720	0.3735	0.5	0.440	0.36	0.39	0.57	1.135	1.04	0.62	0.3790	20,700	-65	200	29.1	MS17984C605 / NAS1336A3C05D	4210.D05
3/8	0.3720	0.3735	0.7	0.440	0.36	0.39	0.57	1.135	1.04	0.62	0.3790	20,700	-65	200	31.8	MS17984C607 / NAS1336A3C07D	4210.D07
3/8	0.3720	0.3735	0.9	0.440	0.36	0.39	0.57	1.135	1.04	0.62	0.3790	20,700	-65	200	34.6	MS17984C609 / NAS1336A3C09D	4210.D09
3/8	0.3720	0.3735	1.0	0.440	0.36	0.39	0.57	1.135	1.04	0.62	0.3790	20,700	-65	200	35.9	MS17984C610 / NAS1336A3C10D	4210.D10
3/8	0.3720	0.3735	1.2	0.440	0.36	0.39	0.57	1.135	1.04	0.62	0.3790	20,700	-65	200	38.6	MS17984C612 / NAS1336A3C12D	4210.D12
3/8	0.3720	0.3735	1.3	0.440	0.36	0.39	0.57	1.135	1.04	0.62	0.3790	20,700	-65	200	40.0	MS17984C613 / NAS1336A3C13D	4210.D13
3/8	0.3720	0.3735	1.4	0.440	0.36	0.39	0.57	1.135	1.04	0.62	0.3790	20,700	-65	200	41.3	MS17984C614 / NAS1336A3C14D	4210.D14
3/8	0.3720	0.3735	1.5	0.440	0.36	0.39	0.57	1.135	1.04	0.62	0.3790	20,700	-65	200	42.7	MS17984C615 / NAS1336A3C15D	4210.D15

Nominal diameter A	A min.	A max.	Clamping length L +0.02 0	Dimensions								Location hole max.	Shearing resistance, two-shear min.				Standard description	Art. No.
				B ±0.005	C 0 -0.04	D max.	E max.	F max.	G max.	H min.	min.			max.				
[in]	[in]	[in]	[in]	[in]								[in]	[lbf]	[°F]		[g]		
3/8	0.3720	0.3735	1.6	0.440	0.36	0.39	0.57	1.135	1.04	0.62	0.3790	20,700	-65	200	44.0	MS17984C616 / NAS1336A3C16D	4210.D16	
3/8	0.3720	0.3735	1.7	0.440	0.36	0.39	0.57	1.135	1.04	0.62	0.3790	20,700	-65	200	45.4	MS17984C617 / NAS1336A3C17D	4210.D17	
3/8	0.3720	0.3735	1.8	0.440	0.36	0.39	0.57	1.135	1.04	0.62	0.3790	20,700	-65	200	46.8	MS17984C618 / NAS1336A3C18D	4210.D18	
3/8	0.3720	0.3735	2.0	0.440	0.36	0.39	0.57	1.135	1.04	0.62	0.3790	20,700	-65	200	49.5	MS17984C620 / NAS1336A3C20D	4210.D20	
3/8	0.3720	0.3735	2.1	0.440	0.36	0.39	0.57	1.135	1.04	0.62	0.3790	20,700	-65	200	50.9	MS17984C621 / NAS1336A3C21D	4210.D21	
3/8	0.3720	0.3735	2.2	0.440	0.36	0.39	0.57	1.135	1.04	0.62	0.3790	20,700	-65	200	52.2	MS17984C622 / NAS1336A3C22D	4210.D22	
3/8	0.3720	0.3735	2.4	0.440	0.36	0.39	0.57	1.135	1.04	0.62	0.3790	20,700	-65	200	54.9	MS17984C624 / NAS1336A3C24D	4210.D24	
3/8	0.3720	0.3735	2.5	0.440	0.36	0.39	0.57	1.135	1.04	0.62	0.3790	20,700	-65	200	56.0	MS17984C625 / NAS1336A3C25D	4210.D25	
3/8	0.3720	0.3735	2.6	0.440	0.36	0.39	0.57	1.135	1.04	0.62	0.3790	20,700	-65	200	57.0	MS17984C626 / NAS1336A3C26D	4210.D26	
3/8	0.3720	0.3735	2.7	0.440	0.36	0.39	0.57	1.135	1.04	0.62	0.3790	20,700	-65	200	59.0	MS17984C627 / NAS1336A3C27D	4210.D27	
3/8	0.3720	0.3735	2.8	0.440	0.36	0.39	0.57	1.135	1.04	0.62	0.3790	20,700	-65	200	60.4	MS17984C628 / NAS1336A3C28D	4210.D28	
3/8	0.3720	0.3735	3.0	0.440	0.36	0.39	0.57	1.135	1.04	0.62	0.3790	20,700	-65	200	63.1	MS17984C630 / NAS1336A3C30D	4210.D30	
3/8	0.3720	0.3735	3.2	0.440	0.36	0.39	0.57	1.135	1.04	0.62	0.3790	20,700	-65	200	65.8	MS17984C632 / NAS1336A3C32D	4210.D32	
3/8	0.3720	0.3735	3.3	0.440	0.36	0.39	0.57	1.135	1.04	0.62	0.3790	20,700	-65	200	67.2	MS17984C633 / NAS1336A3C33D	4210.D33	
3/8	0.3720	0.3735	3.5	0.440	0.36	0.39	0.57	1.135	1.04	0.62	0.3790	20,700	-65	200	69.9	MS17984C635 / NAS1336A3C35D	4210.D35	
3/8	0.3720	0.3735	3.7	0.440	0.36	0.39	0.57	1.135	1.04	0.62	0.3790	20,700	-65	200	73.0	MS17984C637 / NAS1336A3C37D	4210.D37	
3/8	0.3720	0.3735	4.0	0.440	0.36	0.39	0.57	1.135	1.04	0.62	0.3790	20,700	-65	200	76.7	MS17984C640 / NAS1336A3C40D	4210.D40	
3/8	0.3720	0.3735	5.0	0.440	0.36	0.39	0.57	1.135	1.04	0.62	0.3790	20,700	-65	200	90.3	MS17984C650 / NAS1336A3C50D	4210.D50	
7/16	0.4345	0.4360	1.2	0.509	0.38	0.39	0.63	1.400	1.16	0.62	0.4425	28,500	-65	200	49.8	MS17984C712 / NAS1337A3C12D	4210.E12	
7/16	0.4345	0.4360	1.4	0.509	0.38	0.39	0.63	1.400	1.16	0.62	0.4425	28,500	-65	200	54.0	MS17984C714 / NAS1337A3C14D	4210.E14	
7/16	0.4345	0.4360	1.5	0.509	0.38	0.39	0.63	1.400	1.16	0.62	0.4425	28,500	-65	200	55.3	MS17984C715 / NAS1337A3C15D	4210.E15	
7/16	0.4345	0.4360	1.6	0.509	0.38	0.39	0.63	1.400	1.16	0.62	0.4425	28,500	-65	200	57.2	MS17984C716 / NAS1337A3C16D	4210.E16	
7/16	0.4345	0.4360	1.7	0.509	0.38	0.39	0.63	1.400	1.16	0.62	0.4425	28,500	-65	200	59.0	MS17984C717 / NAS1337A3C17D	4210.E17	
7/16	0.4345	0.4360	1.8	0.509	0.38	0.39	0.63	1.400	1.16	0.62	0.4425	28,500	-65	200	61.0	MS17984C718 / NAS1337A3C18D	4210.E18	
7/16	0.4345	0.4360	2.0	0.509	0.38	0.39	0.63	1.400	1.16	0.62	0.4425	28,500	-65	200	64.6	MS17984C720 / NAS1337A3C20D	4210.E20	
7/16	0.4345	0.4360	2.5	0.509	0.38	0.39	0.63	1.400	1.16	0.62	0.4425	28,500	-65	200	73.9	MS17984C725 / NAS1337A3C25D	4210.E25	
7/16	0.4345	0.4360	2.6	0.509	0.38	0.39	0.63	1.400	1.16	0.62	0.4425	28,500	-65	200	75.7	MS17984C726 / NAS1337A3C26D	4210.E26	
7/16	0.4345	0.4360	3.2	0.509	0.38	0.39	0.63	1.400	1.16	0.62	0.4425	28,500	-65	200	86.9	MS17984C732 / NAS1337A3C32D	4210.E32	
7/16	0.4345	0.4360	3.8	0.509	0.38	0.39	0.63	1.400	1.16	0.62	0.4425	28,500	-65	200	98.0	MS17984C738 / NAS1337A3C38D	4210.E38	
7/16	0.4345	0.4360	4.0	0.509	0.38	0.39	0.63	1.400	1.16	0.62	0.4425	28,500	-65	200	102.0	MS17984C740 / NAS1337A3C40D	4210.E40	
7/16	0.4345	0.4360	5.0	0.509	0.38	0.39	0.63	1.400	1.16	0.62	0.4425	28,500	-65	200	120.0	MS17984C750 / NAS1337A3C50D	4210.E50	
1/2	0.4970	0.4985	0.5	0.594	0.46	0.56	0.72	1.400	1.19	0.72	0.5050	36,900	-65	200	53.0	MS17984C805 / NAS1338A3C05D	4210.F05	

Nominal diameter A	A min.	A max.	Clamping length L +0.02 0	Dimensions							Location hole max.	Shearing resistance, two-shear min.				Standard description	Art. No.
				B ±0.005	C 0 -0.04	D max.	E max.	F max.	G max.	H min.			min.	max.			
[in]	[in]	[in]	[in]	[in]							[in]	[lbf]	[°F]		[g]		
1/2	0.4970	0.4985	0.8	0.594	0.46	0.56	0.72	1.400	1.19	0.72	0.5050	36,900	-65	200	61.0	MS17984C808 / NAS1338A3C08D	4210.F08
1/2	0.4970	0.4985	1.1	0.594	0.46	0.56	0.72	1.400	1.19	0.72	0.5050	36,900	-65	200	68.0	MS17984C811 / NAS1338A3C11D	4210.F11
1/2	0.4970	0.4985	1.3	0.594	0.46	0.56	0.72	1.400	1.19	0.72	0.5050	36,900	-65	200	73.0	MS17984C813 / NAS1338A3C13D	4210.F13
1/2	0.4970	0.4985	1.4	0.594	0.46	0.56	0.72	1.400	1.19	0.72	0.5050	36,900	-65	200	75.0	MS17984C814 / NAS1338A3C14D	4210.F14
1/2	0.4970	0.4985	1.5	0.594	0.46	0.56	0.72	1.400	1.19	0.72	0.5050	36,900	-65	200	78.0	MS17984C815 / NAS1338A3C15D	4210.F15
1/2	0.4970	0.4985	1.7	0.594	0.46	0.56	0.72	1.400	1.19	0.72	0.5050	36,900	-65	200	82.0	MS17984C817 / NAS1338A3C17D	4210.F17
1/2	0.4970	0.4985	1.8	0.594	0.46	0.56	0.72	1.400	1.19	0.72	0.5050	36,900	-65	200	85.0	MS17984C818 / NAS1338A3C18D	4210.F18
1/2	0.4970	0.4985	2.0	0.594	0.46	0.56	0.72	1.400	1.19	0.72	0.5050	36,900	-65	200	90.0	MS17984C820 / NAS1338A3C20D	4210.F20
1/2	0.4970	0.4985	2.1	0.594	0.46	0.56	0.72	1.400	1.19	0.72	0.5050	36,900	-65	200	92.0	MS17984C821 / NAS1338A3C21D	4210.F21
1/2	0.4970	0.4985	2.2	0.594	0.46	0.56	0.72	1.400	1.19	0.72	0.5050	36,900	-65	200	95.0	MS17984C822 / NAS1338A3C22D	4210.F22
1/2	0.4970	0.4985	2.4	0.594	0.46	0.56	0.72	1.400	1.19	0.72	0.5050	36,900	-65	200	100.0	MS17984C824 / NAS1338A3C24D	4210.F24
1/2	0.4970	0.4985	2.6	0.594	0.46	0.56	0.72	1.400	1.19	0.72	0.5050	36,900	-65	200	104.0	MS17984C826 / NAS1338A3C26D	4210.F26
1/2	0.4970	0.4985	2.7	0.594	0.46	0.56	0.72	1.400	1.19	0.72	0.5050	36,900	-65	200	107.0	MS17984C827 / NAS1338A3C27D	4210.F27
1/2	0.4970	0.4985	2.8	0.594	0.46	0.56	0.72	1.400	1.19	0.72	0.5050	36,900	-65	200	109.0	MS17984C828 / NAS1338A3C28D	4210.F28
1/2	0.4970	0.4985	3.0	0.594	0.46	0.56	0.72	1.400	1.19	0.72	0.5050	36,900	-65	200	114.0	MS17984C830 / NAS1338A3C30D	4210.F30
1/2	0.4970	0.4985	3.1	0.594	0.46	0.56	0.72	1.400	1.19	0.72	0.5050	36,900	-65	200	117.0	MS17984C831 / NAS1338A3C31D	4210.F31
1/2	0.4970	0.4985	3.2	0.594	0.46	0.56	0.72	1.400	1.19	0.72	0.5050	36,900	-65	200	119.0	MS17984C832 / NAS1338A3C32D	4210.F32
1/2	0.4970	0.4985	3.3	0.594	0.46	0.56	0.72	1.400	1.19	0.72	0.5050	36,900	-65	200	121.0	MS17984C833 / NAS1338A3C33D	4210.F33
1/2	0.4970	0.4985	3.6	0.594	0.46	0.56	0.72	1.400	1.19	0.72	0.5050	36,900	-65	200	129.0	MS17984C836 / NAS1338A3C36D	4210.F36
1/2	0.4970	0.4985	3.9	0.594	0.46	0.56	0.72	1.400	1.19	0.72	0.5050	36,900	-65	200	136.0	MS17984C839 / NAS1338A3C39D	4210.F39
1/2	0.4970	0.4985	4.0	0.594	0.46	0.56	0.72	1.400	1.19	0.72	0.5050	36,900	-65	200	138.0	MS17984C840 / NAS1338A3C40D	4210.F40
1/2	0.4970	0.4985	4.1	0.594	0.46	0.56	0.72	1.400	1.19	0.72	0.5050	36,900	-65	200	141.0	MS17984C841 / NAS1338A3C41D	4210.F41
1/2	0.4970	0.4985	6.0	0.594	0.46	0.56	0.72	1.400	1.19	0.72	0.5050	36,900	-65	200	187.0	MS17984C860 / NAS1338A3C60D	4210.F60
9/16	0.5595	0.5610	1.3	0.666	0.51	0.56	0.77	1.650	1.41	0.95	0.5675	46,700	-65	200	90.2	MS17984C913 / NAS1339A3C13D	4210.G13
9/16	0.5595	0.5610	1.5	0.666	0.51	0.56	0.77	1.650	1.41	0.95	0.5675	46,700	-65	200	96.4	MS17984C915 / NAS1339A3C15D	4210.G15
9/16	0.5595	0.5610	1.7	0.666	0.51	0.56	0.77	1.650	1.41	0.95	0.5675	46,700	-65	200	103.0	MS17984C917 / NAS1339A3C17D	4210.G17
9/16	0.5595	0.5610	2.0	0.666	0.51	0.56	0.77	1.650	1.41	0.95	0.5675	46,700	-65	200	112.0	MS17984C920 / NAS1339A3C20D	4210.G20
9/16	0.5595	0.5610	2.5	0.666	0.51	0.56	0.77	1.650	1.41	0.95	0.5675	46,700	-65	200	127.0	MS17984C925 / NAS1339A3C25D	4210.G25
9/16	0.5595	0.5610	3.4	0.666	0.51	0.56	0.77	1.650	1.41	0.95	0.5675	46,700	-65	200	155.0	MS17984C934 / NAS1339A3C34D	4210.G34
9/16	0.5595	0.5610	4.0	0.666	0.51	0.56	0.77	1.650	1.41	0.95	0.5675	46,700	-65	200	174.0	MS17984C940 / NAS1339A3C40D	4210.G40
5/8	0.6220	0.6235	1.4	0.750	0.58	0.58	0.87	1.700	0.95	0.95	0.6300	57,800	-65	200	131.0	MS17984C1014 / NAS1340A3C14D	4210.H14
5/8	0.6220	0.6235	1.5	0.750	0.58	0.58	0.87	1.700	0.95	0.95	0.6300	57,800	-65	200	134.0	MS17984C1015 / NAS1340A3C15D	4210.H15

Nominal diameter A	A min.	A max.	Clamping length L +0.02 0	Dimensions							Location hole max.	Shearing resistance, two-shear min.				Standard description	Art. No.
				B ±0.005	C 0 -0.04	D max.	E max.	F max.	G max.	H min.			min.	max.			
[in]	[in]	[in]	[in]	[in]							[in]	[lbf]	[°F]		[g]		
5/8	0.6220	0.6235	1.7	0.750	0.58	0.58	0.87	1.700	0.95	0.95	0.6300	57,800	-65	200	142.0	MS17984C1017 / NAS1340A3C17D	4210.H17
5/8	0.6220	0.6235	1.8	0.750	0.58	0.58	0.87	1.700	0.95	0.95	0.6300	57,800	-65	200	146.0	MS17984C1018 / NAS1340A3C18D	4210.H18
5/8	0.6220	0.6235	2.0	0.750	0.58	0.58	0.87	1.700	0.95	0.95	0.6300	57,800	-65	200	115.0	MS17984C1020 / NAS1340A3C20D	4210.H20
5/8	0.6220	0.6235	3.2	0.750	0.58	0.58	0.87	1.700	0.95	0.95	0.6300	57,800	-65	200	200.0	MS17984C1032 / NAS1340A3C32D	4210.H32
5/8	0.6220	0.6235	3.7	0.750	0.58	0.58	0.87	1.700	0.95	0.95	0.6300	57,800	-65	200	219.0	MS17984C1037 / NAS1340A3C37D	4210.H37
5/8	0.6220	0.6235	4.0	0.750	0.58	0.58	0.87	1.700	0.95	0.95	0.6300	57,800	-65	200	231.0	MS17984C1040 / NAS1340A3C40D	4210.H40
3/4	0.7470	0.7485	1.8	0.887	0.67	0.70	1.00	1.900	1.68	1.14	0.7570	83,200	-65	200	207.0	MS17984C1218 / NAS1341A3C18D	4210.K18
3/4	0.7470	0.7485	2.0	0.887	0.67	0.70	1.00	1.900	1.68	1.14	0.7570	83,200	-65	200	218.0	MS17984C1220 / NAS1341A3C20D	4210.K20
3/4	0.7470	0.7485	2.2	0.887	0.67	0.70	1.00	1.900	1.68	1.14	0.7570	83,200	-65	200	229.0	MS17984C1222 / NAS1341A3C22D	4210.K22
3/4	0.7470	0.7485	2.4	0.887	0.67	0.70	1.00	1.900	1.68	1.14	0.7570	83,200	-65	200	240.0	MS17984C1224 / NAS1341A3C24D	4210.K24
3/4	0.7470	0.7485	2.5	0.887	0.67	0.70	1.00	1.900	1.68	1.14	0.7570	83,200	-65	200	246.0	MS17984C1225 / NAS1341A3C25D	4210.K25
3/4	0.7470	0.7485	3.0	0.887	0.67	0.70	1.00	1.900	1.68	1.14	0.7570	83,200	-65	200	274.0	MS17984C1230 / NAS1341A3C30D	4210.K30
3/4	0.7470	0.7485	4.0	0.887	0.67	0.70	1.00	1.900	1.68	1.14	0.7570	83,200	-65	200	329.0	MS17984C1240 / NAS1341A3C40D	4210.K40
3/4	0.7470	0.7485	5.5	0.887	0.67	0.70	1.00	1.900	1.68	1.14	0.7570	83,200	-65	200	422.0	MS17984C1255 / NAS1341A3C55D	4210.K55
7/8	0.8735	0.8750	2.6	1.046	0.76	0.84	1.13	2.250	1.98	1.27	0.8820	112,500	-65	200	371.0	MS17984C1426 / NAS1342A3C26D	4210.L26
7/8	0.8735	0.8750	3.2	1.046	0.76	0.84	1.13	2.250	1.98	1.27	0.8820	112,500	-65	200	417.0	MS17984C1432 / NAS1342A3C32D	4210.L32
7/8	0.8735	0.8750	4.0	1.046	0.76	0.84	1.13	2.250	1.98	1.27	0.8820	112,500	-65	200	477.0	MS17984C1440 / NAS1342A3C40D	4210.L40
1	0.9970	0.9985	3.8	1.219	0.89	0.95	1.25	2.250	2.14	1.49	1.0100	147,200	-65	200	546.0	MS17984C1633 / NAS1343A3C33D	4210.M33
1	0.9970	0.9985	3.8	1.219	0.89	0.95	1.25	2.250	2.14	1.49	1.0100	147,200	-65	200	596.0	MS17984C1638 / NAS1343A3C38D	4210.M38
1	0.9970	0.9985	4.0	1.219	0.89	0.95	1.25	2.250	2.14	1.49	1.0100	147,200	-65	200	615.0	MS17984C1640 / NAS1343A3C40D	4210.M40
1	0.9970	0.9985	4.5	1.219	0.89	0.95	1.25	2.250	2.14	1.49	1.0100	147,200	-65	200	665.0	MS17984C1645 / NAS1343A3C45D	4210.M45

Compliance

RoHS compliant

Compliant according to Directive 2011/65/EU and Directive 2015/863.

Does not contain SVHC substances

No SVHC substances with more than 0.1% w/w contained - SVHC list [REACH] as of 27.06.2024.

Does not contain Proposition 65 substances

No Proposition 65 substances included.

<https://www.P65Warnings.ca.gov/>

Free from Conflict Minerals

This product does not contain any substances designated as "conflict minerals" such as tantalum, tin, gold or tungsten from the Democratic Republic of Congo or adjacent countries.