

Star Grip Screws • similar to DIN 6336, stainless steel A4 EH 24741.



Product Description

These star grip screws are manufactured according to DIN 6336, but it is a version without dirty edges. This makes these star grip screws suitable for all areas of application with high hygienic requirements.

The stainless steel A4 version ensures maximum corrosion resistance.

Material

Handle

- Stainless steel 1.4408, precision casting, polished

Screw

- Stainless steel A4

Drawing

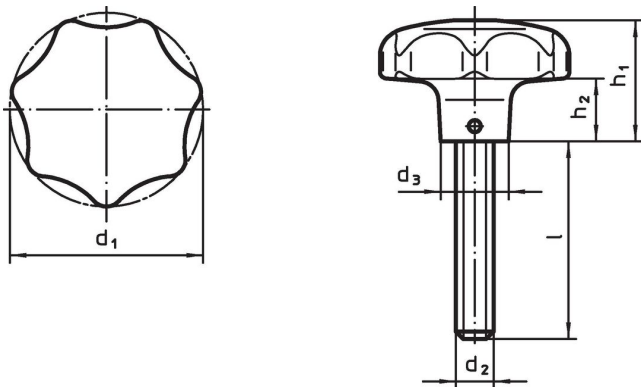

Order information

d ₁	d ₂	Dimensions				[g]	Art. No.
		l [mm]	d ₃	h ₁	h ₂		
40	M 8	20	14	25	12	118	24741.0105
40	M 8	25	14	25	12	115	24741.0110
40	M 8	30	14	25	12	120	24741.0115
40	M 8	40	14	25	12	124	24741.0120
50	M10	20	18	32	15	229	24741.0125
50	M10	25	18	32	15	232	24741.0130
50	M10	30	18	32	15	234	24741.0135
50	M10	45	18	32	15	242	24741.0140
50	M10	55	18	32	15	252	24741.0145
63	M12	30	20	40	19	429	24741.0150
63	M12	40	20	40	19	435	24741.0155
63	M12	50	20	40	19	442	24741.0160

Compliance

RoHS compliant

Compliant according to Directive 2011/65/EU and Directive 2015/863.

Does not contain SVHC substances

No SVHC substances with more than 0.1% w/w contained - SVHC list [REACH] as of 27.06.2024.

Does not contain Proposition 65 substances

No Proposition 65 substances included.

<https://www.P65Warnings.ca.gov/>

Free from Conflict Minerals

This product does not contain any substances designated as "conflict minerals" such as tantalum, tin, gold or tungsten from the Democratic Republic of Congo or adjacent countries.