

Star Grips • DIN 6336 stainless steel die-cast  
EH 24661.



**Product Description**

These star grips are manufactured according to DIN 6336.

**Material**

**Handle**

- Stainless steel A2, dull blasted

**Drawing**

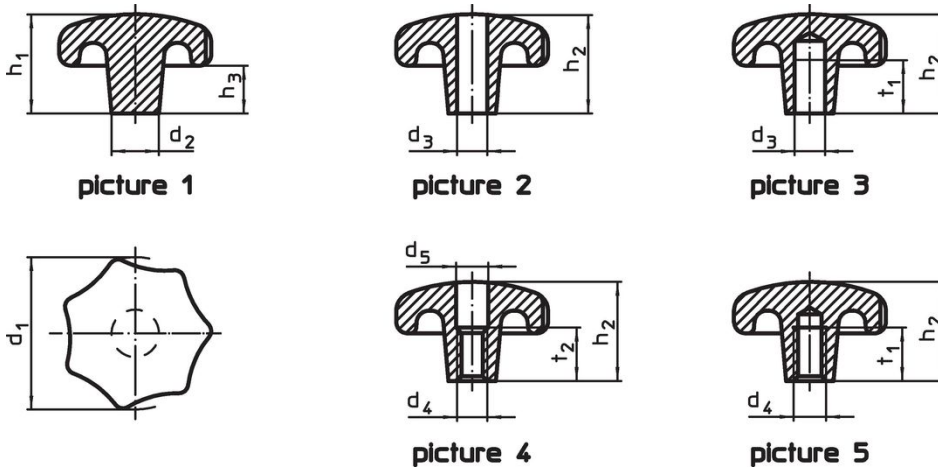

**Order information**

d <sub>1</sub>	d <sub>2</sub>	d <sub>4</sub>	Dimensions						[g]	Art. No.	
			d <sub>5</sub>	h <sub>1</sub>	h <sub>2</sub>	h <sub>3</sub>	t <sub>1</sub> min.	t <sub>2</sub>			
[mm]											
<b>raw part, form A – picture 1</b>											
32	12	–	–	21	–	–	10	–	–	56	<a href="#">24661.0032</a>
40	14	–	–	26	–	–	13	–	–	85	<a href="#">24661.0040</a>
50	18	–	–	34	–	–	17	–	–	181	<a href="#">24661.0050</a>
63	20	–	–	42	–	–	21	–	–	319	<a href="#">24661.0063</a>
<b>with thread, drilled out, form D – picture 4</b>											
32	12	M 6	6.4	–	20	–	–	–	10	52	<a href="#">24661.0332</a>
40	14	M 8	8.4	–	25	–	–	–	13	75	<a href="#">24661.0340</a>
50	18	M10	10.5	–	32	–	–	–	16	149	<a href="#">24661.0350</a>
63	20	M12	13.0	–	40	–	–	–	20	279	<a href="#">24661.0363</a>
<b>with threaded blind hole, form E – picture 5</b>											
32	12	M 6	–	–	20	–	–	12	–	53	<a href="#">24661.0432</a>
40	14	M 8	–	–	25	–	–	15	–	77	<a href="#">24661.0440</a>
50	18	M10	–	–	32	–	–	18	–	158	<a href="#">24661.0450</a>
63	20	M12	–	–	40	–	–	22	–	296	<a href="#">24661.0463</a>

## Compliance

### RoHS compliant

Compliant according to Directive 2011/65/EU and Directive 2015/863.

### Does not contain SVHC substances

No SVHC substances with more than 0.1% w/w contained - SVHC list [REACH] as of 27.06.2024.

### Does not contain Proposition 65 substances

No Proposition 65 substances included.

<https://www.P65Warnings.ca.gov/>

### Free from Conflict Minerals

This product does not contain any substances designated as "conflict minerals" such as tantalum, tin, gold or tungsten from the Democratic Republic of Congo or adjacent countries.