

U-Handles · front mounting

EH 24300.



Product Description

U-handles are used, for example, on machine doors, furniture doors, cabinet doors, drawers and drawer units.

These U-handles are characterised by their ergonomic profile design with very high stability and their simple and timeless design.

Material

Handle

- Aluminium, drawn, bright, vibratory grinded
- Aluminium, plastic coated, similar to RAL 9005, black
- stainless steel, dull blasted

Assembly

Mounting is done from the operating side by means of a cylinder screw.

Drawing

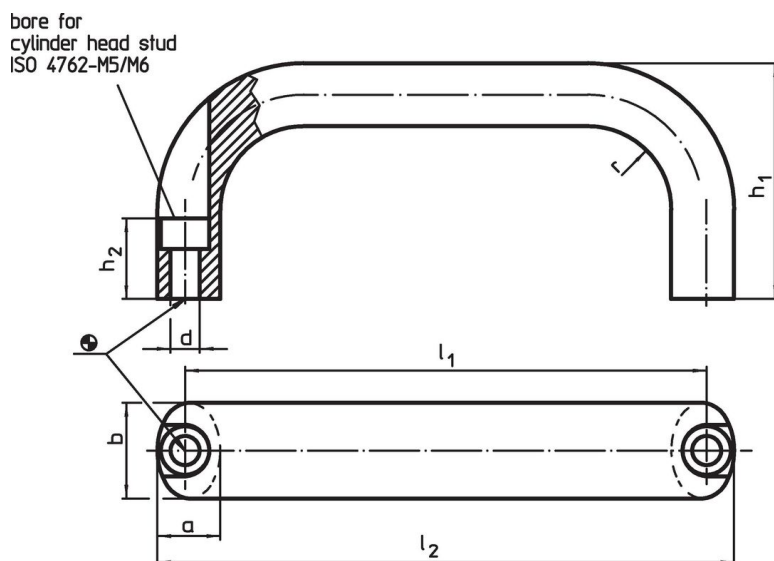

Order information

b	l ₁ ±0.25	l ₂	Dimensions					r	For cylinder screw [mm]	[g]	Art. No.
			a	d	h ₁	h ₂	[mm]				
Aluminium, drawn, bright, vibratory grinded											
20	100	112	13	5.4	49	19	13	M5	80	24300.0101	
20	112	124	13	5.4	49	19	13	M5	82	24300.0111	
20	117	129	13	5.4	49	19	13	M5	84	24300.0113	
20	120	132	13	5.4	51	19	13	M5	90	24300.0115	
20	128	140	13	5.4	51	19	13	M5	100	24300.0121	
20	160	172	13	5.4	51	19	13	M5	100	24300.0131	
26	116	130	17	6.4	55	17	17	M6	146	24300.0141	
26	120	134	17	6.4	55	17	17	M6	152	24300.0143	
26	132	146	17	6.4	55	17	17	M6	161	24300.0151	
26	164	178	17	6.4	57	17	17	M6	196	24300.0161	
26	179	193	17	6.4	57	17	17	M6	215	24300.0166	
26	196	210	17	6.4	57	17	17	M6	229	24300.0171	
Aluminium, plastic coated, similar to RAL 9005, black											
20	100	112	13	5.4	49	19	13	M5	80	24300.0301	
20	112	124	13	5.4	49	19	13	M5	82	24300.0311	
20	117	129	13	5.4	49	19	13	M5	84	24300.0313	
20	120	132	13	5.4	49	19	13	M5	90	24300.0315	
20	128	140	13	5.4	51	19	13	M5	100	24300.0321	
20	160	172	13	5.4	51	19	13	M5	120	24300.0331	

b	l ₁ ±0.25	l ₂	Dimensions					For cylinder screw		Art. No.
			a	d	h ₁	h ₂	r			
[mm]								[mm]	[g]	
26	116	130	17	6.4	55	17	17	M6	132	24300.0341
26	120	134	17	6.4	55	17	17	M6	152	24300.0343
26	132	146	17	6.4	55	17	17	M6	166	24300.0351
26	164	178	17	6.4	57	17	17	M6	206	24300.0361
26	179	193	17	6.4	57	17	17	M6	213	24300.0366
26	196	210	17	6.4	57	17	17	M6	232	24300.0371
stainless steel, dull blasted										
20	112	124	13	5.4	49	19	13	M5	258	24300.0511
20	128	140	13	5.4	51	19	13	M5	293	24300.0521
20	160	172	13	5.4	51	19	13	M5	345	24300.0531
26	128	140	17	6.4	57	17	19	M6	455	24300.0655
26	160	172	17	6.4	57	17	19	M6	542	24300.0665
26	200	216	17	6.4	57	17	19	M6	651	24300.0675

Application example

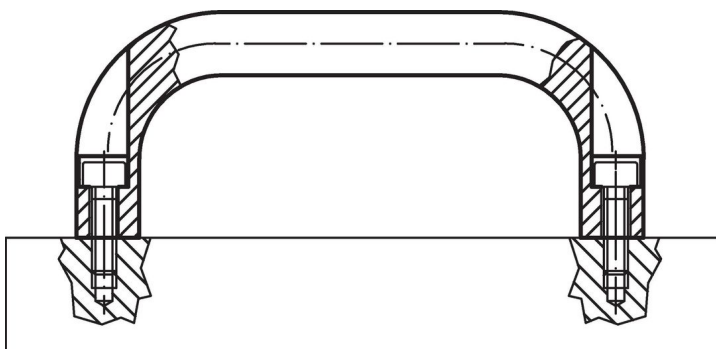

Compliance

RoHS compliant

Compliant according to Directive 2011/65/EU and Directive 2015/863.

Does not contain SVHC substances

No SVHC substances with more than 0.1% w/w contained - SVHC list [REACH] as of 23.01.2024.

Does not contain Proposition 65 substances

No Proposition 65 substances included.

<https://www.P65Warnings.ca.gov/>

Free from Conflict Minerals

This product does not contain any substances designated as "conflict minerals" such as tantalum, tin, gold or tungsten from the Democratic Republic of Congo or adjacent countries.