

Clamping Elements

EH 23700.



Product Description

Material

Body

- Steel, blackened

Wearing parts

- Heat-treated steel

Pull-rod

- Special steel

More information

Further products

- Straight Clamps, long
- Intermediate Elements
- Intermediate Elements, with support
- Base Elements
- Base Elements, swivelling
- Base Elements, low
- Base Elements, for location hole

Drawing

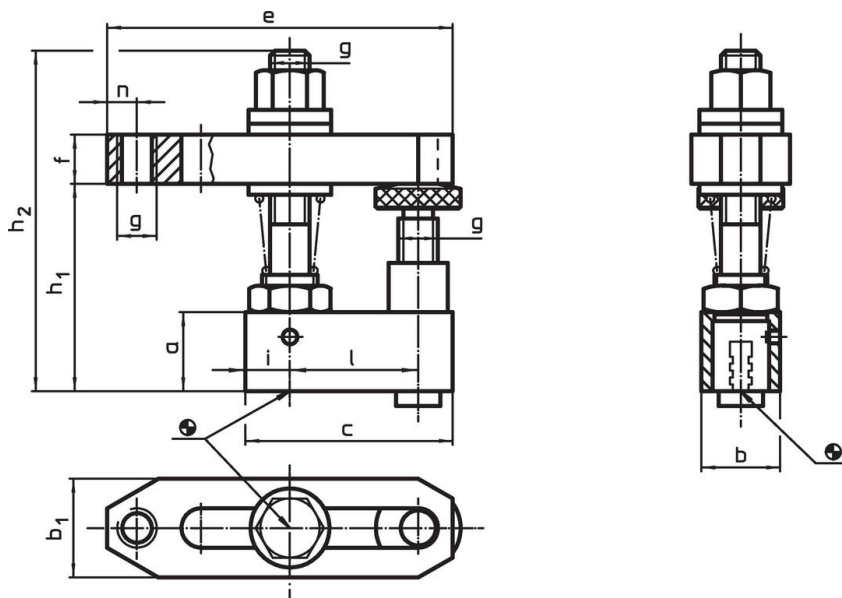

Order information

Dimensions													🔧 [g]	Art. No.
a	b	c	b ₁	e	f	g	h ₁	h ₂	i	l	n	[mm]		
25	25	65	35	110	20	M12	48 – 78	112	12.5	40	10		870	23700.0012
30	30	78	40	142	30	M16	60 – 96	145	14.0	50	13		1703	23700.0016

Application example

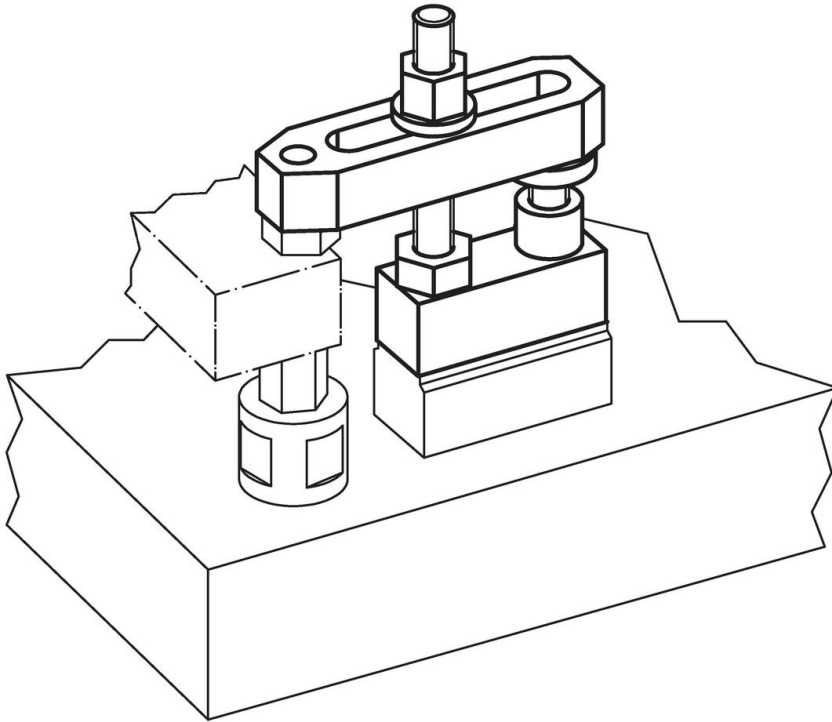

Compliance

RoHS compliant

Compliant according to Directive 2011/65/EU and Directive 2015/863.

Does not contain SVHC substances

No SVHC substances with more than 0.1% w/w contained - SVHC list [REACH] as of 23.01.2024.

Does not contain Proposition 65 substances

No Proposition 65 substances included.

<https://www.P65Warnings.ca.gov/>

Free from Conflict Minerals

This product does not contain any substances designated as "conflict minerals" such as tantalum, tin, gold or tungsten from the Democratic Republic of Congo or adjacent countries.