

Centering Clamping Elements · with clamping balls

EH 23340.



Product Description

To be used for accurate centering and clamping of workpieces with locating hole on which light spherical marks are acceptable. Exact self-centering with a precision of $\pm 0,025$ mm. The clamping balls frictionally center and hold workpieces with raw or pre-machined surfaces down to the bearing points. Large adjustment stroke and a small building height are a feature of this center clamping element.

Mounting from either top or bottom.

Material

Body

- Tool steel, hardened, blackened

Spring

- Stainless steel

Clamping balls

- Stainless steel 1.4112, hardened and ground

Assembly

Assembly instruction for mounting from above: Remove clamping plate and screw. Screw in threaded pin from below, and tighten from above using female WS_2 .

Further or detailed information can be found in the assembly and operating instructions.

More information

Further products

- Centering Clamping Elements, with clamping segments
- Centering Clamping Elements, with clamping segments, operation from the bottom
- Centering Clamping Elements, with clamping balls, operation from the bottom

Drawing

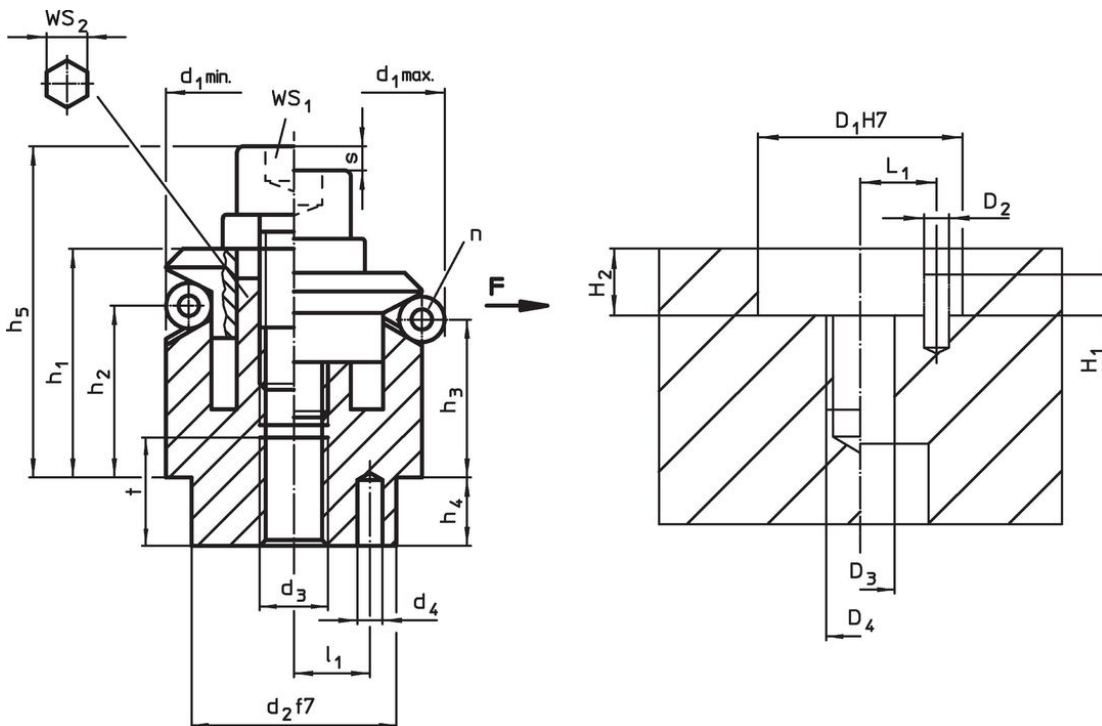

Order information

Dimensions														Number of balls n	Stroke s	WS		Clamping force F max. [kN]	Tightening torque max. [Nm]	Location hole							Art. No.
d ₁ min.	d ₁ max.	d ₂ f7	d ₃	d ₄ +0.3	h ₁ -1	h ₂	h ₃	h ₄	h ₅ -2	l ₁ ±0.1	Ball diameter	t	WS ₁			WS ₂	D ₁ H7			D ₂	D ₃	D ₄	H ₁	H ₂ +0.5	L ₁ ±0.1	[g]	
[mm]														[mm]	[mm]	[kN]	[Nm]	[mm]							[g]		
11.7	14.2	10	M 4	1.5	8.6	3.9	3.2	3.5	14.7	3.5	2.5	4	3	1.3	3	-	0.5	5	10	1.5	4	M 4	2.0	3.5	3.5	18	23340.0212 ¹⁾
14.5	18.5	12	M 4	2.0	14.2	9.8	8.6	5.5	19.2	4.5	4.0	6	3	2.3	3	5	3.5	5	12	2.0	4	M 4	2.5	5.5	4.5	26	23340.0214
18.5	22.5	15	M 5	2.5	16.5	11.6	10.4	7.5	22.7	5.5	4.0	7	3	2.3	4	5	4.5	10	15	2.5	5	M 5	3.5	7.5	5.5	38	23340.0218
22.5	26.5	20	M 6	3.0	19.6	14.1	12.9	6.0	28.6	7.0	4.0	8	3	2.3	5	6	5.0	17	20	3.0	6	M 6	3.5	6.0	7.0	73	23340.0222
26.5	30.5	20	M 6	3.0	19.8	14.1	13.0	6.0	28.8	7.0	4.0	8	3	2.3	5	6	5.0	17	20	3.0	6	M 6	3.5	6.0	7.0	93	23340.0226
30.5	38.5	25	M 6	4.0	23.2	14.1	11.8	7.0	32.2	9.0	8.0	8	3	4.6	5	6	5.0	17	25	4.0	6	M 6	3.5	7.0	9.0	119	23340.0230
38.5	46.5	30	M 8	4.0	27.2	18.0	15.7	7.5	39.2	11.0	8.0	10	6	4.6	6	8	6.5	43	30	4.0	8	M 8	4.5	7.5	11.0	254	23340.0238
46.5	54.5	30	M 8	4.0	27.1	18.0	15.7	7.5	39.2	11.0	8.0	10	6	4.6	6	8	6.5	43	30	4.0	8	M 8	6.5	7.5	11.0	342	23340.0246
54.5	70.5	45	M10	5.0	40.6	23.7	19.1	9.0	54.6	15.0	16.0	12	6	9.2	8	10	8.0	79	45	5.0	10	M10	6.5	9.0	15.0	664	23340.0254
70.5	86.5	60	M12	5.0	46.1	28.3	23.7	10.0	63.1	17.0	16.0	15	6	9.2	10	12	10.0	141	60	5.0	12	M12	6.5	10.0	17.0	1312	23340.0270
86.5	102.5	60	M16	5.0	51.2	30.3	25.6	10.0	72.2	25.0	16.0	15	6	9.2	14	17	10.0	354	60	5.0	16	M16	6.5	10.0	25.0	2000	23340.0286

¹⁾ no WS₂ clamping screw and threaded pin to be mounted from top

Application example

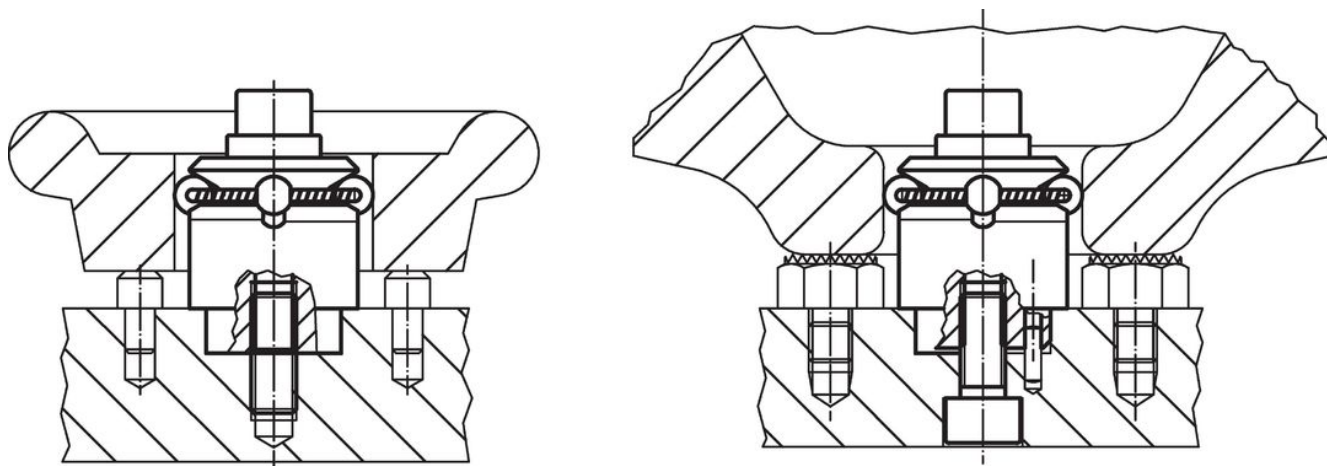

Compliance

RoHS compliant

Compliant according to Directive 2011/65/EU and Directive 2015/863.

Does not contain SVHC substances

No SVHC substances with more than 0.1% w/w contained - SVHC list [REACH] as of 27.06.2024.

Does not contain Proposition 65 substances

No Proposition 65 substances included.

<https://www.P65Warnings.ca.gov/>

Free from Conflict Minerals

This product does not contain any substances designated as "conflict minerals" such as tantalum, tin, gold or tungsten from the Democratic Republic of Congo or adjacent countries.