

Holding Plates • for down-hold clamps

EH 23210.



Product Description

By using the holding plates, the down-hold clamps can also be placed in any desired position across the T-slots.

Material

- Heat-treated steel, tempered, blackened

Drawing

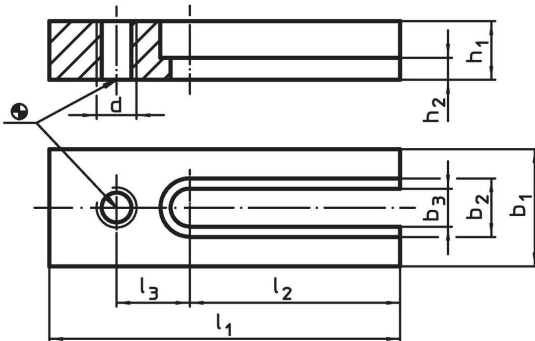

Order information

b ₁	b ₂	b ₃	d	Dimensions					For down-hold clamps	[g]	Art. No.
				h ₁ -0.4 [mm]	h ₂	l ₁	l ₂	l ₃			
30	15	9	M 8	15	6.5	100	63	20	M 8	243	23210.0730
40	20	13	M12	20	7.5	120	72	25	M12	515	23210.0740
60	26	17	M16	30	13.0	140	80	30	M16	1456	23210.0760
80	32	21	M20	40	18.0	200	110	50	–	3900	23210.0770
90	38	25	M24	50	24.0	220	130	55	–	5850	23210.0780

Application example

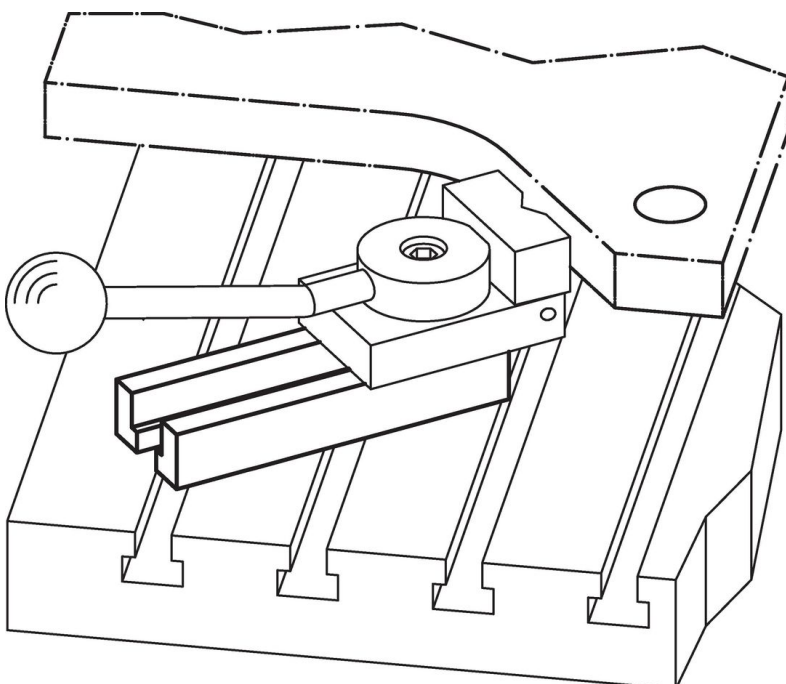

Compliance

RoHS compliant

Compliant according to Directive 2011/65/EU and Directive 2015/863.

Does not contain SVHC substances

No SVHC substances with more than 0.1% w/w contained - SVHC list [REACH] as of 27.06.2024.

Does not contain Proposition 65 substances

No Proposition 65 substances included.

<https://www.P65Warnings.ca.gov/>

Free from Conflict Minerals

This product does not contain any substances designated as "conflict minerals" such as tantalum, tin, gold or tungsten from the Democratic Republic of Congo or adjacent countries.