

Support Extensions • for straight clamps, slotted, with adjustable counter piece

EH 23185.



Product Description

The support extension is screwed on the counter piece of the clamp EH 23185. for an extension of the clamping height (dimension h_2). The clamping height can be adjusted steplessly by means of the support extension.

Material

Body

- Steel, tempered, zinc-plated by galvanization

Supporting bolt

- Heat-treated steel, quality 8.8, black

Drawing

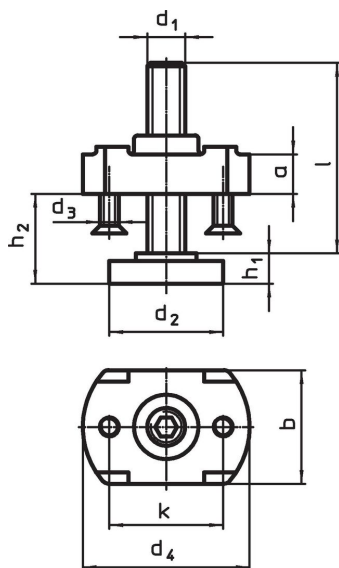

Order information

d ₁	l	d ₂	d ₃	Dimensions						for clamps d ₁ [mm]	🔩 [g]	Art. No.
				d ₄	h ₁	h ₂	a	b	k			
[mm]												
M10	39	30	M5	44	8	8 – 30	10	30	30	13	148	23185.0410
M12	49	36	M5	54	10	10 – 37	16	42	35	17	345	23185.0412
M12	94	36	M5	54	10	10 – 80	16	42	35	17	473	23185.0413
M16	55	42	M5	60	13	13 – 41	20	50	40	21	494	23185.0416
M16	90	42	M5	60	13	13 – 73	20	50	40	21	640	23185.0417
M20	69	50	M6	70	16	16 – 52	25	46	50	25	1136	23185.0420
M20	109	50	M6	70	16	16 – 91	25	46	50	25	1001	23185.0421

Application example



Compliance

RoHS compliant

Compliant according to Directive 2011/65/EU and Directive 2015/863.

Does not contain SVHC substances

No SVHC substances with more than 0.1% w/w contained - SVHC list [REACH] as of 23.01.2024.

Does not contain Proposition 65 substances

No Proposition 65 substances included.

<https://www.P65Warnings.ca.gov/>

Free from Conflict Minerals

This product does not contain any substances designated as "conflict minerals" such as tantalum, tin, gold or tungsten from the Democratic Republic of Congo or adjacent countries.