

Expander® Sealing Plugs • body from stainless steel

EH 22880.



Product Description

Expander® sealing plugs are used for safe, quick and economic sealing of bore holes in fluid technology, e.g. hydraulic drilling holes in jig and fixture construction. Assembly is effected by pressing in the sealing plug into the drilling hole by means of the prescribed setting die.

Please refer to the technical data following these product information pages.

Material

Body

- Stainless steel 1.4305

Ball

- Roller bearing steel, heat-treated, tempered

More information

Further products

- Expander® Sealing Plugs, body from case-hardened steel
- Expander® Sealing Plugs, body and ball from stainless steel
- Setting Dies, for Expander® sealing plug

Drawing

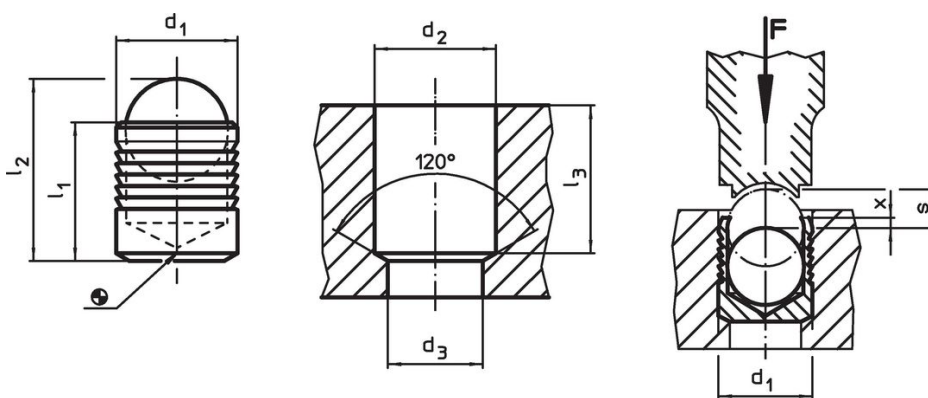

Order information

d ₁	l ₁	l ₂ ~	Dimensions					s	[g]	Art. No.
			d ₂ +0.1	d ₃ max.	l ₃ min.	x ±0.2	[mm]			
body from stainless steel, ball from steel										
3	3.6	4.6	3	2.2	3.4	0.4	1.20	0.2	22880.0053	
4	4.0	5.2	4	3.3	3.8	0.2	1.50	0.4	22880.0054	
5	5.5	7.0	5	4.3	5.3	0.4	2.00	0.7	22880.0055	
6	6.5	8.6	6	5.3	6.3	0.4	2.50	1.3	22880.0056	
7	7.5	10.1	7	6.4	7.3	0.4	3.00	1.9	22880.0057	
8	8.5	11.7	8	7.4	8.3	0.3	3.50	3.2	22880.0058	
9	10.0	13.7	9	8.4	9.8	0.4	4.00	4.5	22880.0059	
10	11.0	15.2	10	9.4	10.8	0.4	4.50	6.1	22880.0060	
12	13.0	18.0	12	10.6	12.8	0.4	5.50	9.7	22880.0062	
14	15.0	20.8	14	12.7	14.5	0.4	6.35	15.0	22880.0064	
16	17.0	23.7	16	14.7	16.5	0.6	7.00	22.0	22880.0066	
18	19.0	26.3	18	16.7	18.5	0.6	8.00	31.0	22880.0068	
20	22.0	30.5	20	18.7	21.5	0.8	9.00	46.0	22880.0070	
22	25.0	34.2	22	20.7	24.5	0.8	10.00	58.0	22880.0072	

Application example

Working and control pressures for Expander® sealing plug, sleeve from stainless steel 1.4305							
basic material	ETG-100 AISI 1144	C15Pb 1.0403	GG-25 DIN 1691	GGG-50 DIN 1693	AlCuMg2 3.1354	AlMgSiPb 3.0615	G-AISI7Mg 3.2371
d ₁ 3-10 mm	p [bar]						
	450	450	450	450	450	380	380
	pTest [bar]						
	1400	1400	1400	1400	1400	1200	1200
d ₁ 12-22 mm	p [bar]						
	350	350	350	350	350	280	280
	pTest [bar]						
	1150	1150	1150	1150	1150	900	900

Compliance

RoHS compliant

Compliant according to Directive 2011/65/EU and Directive 2015/863.

Does not contain SVHC substances

No SVHC substances with more than 0.1% w/w contained - SVHC list [REACH] as of 27.06.2024.

Does not contain Proposition 65 substances

No Proposition 65 substances included.

<https://www.P65Warnings.ca.gov/>

Free from Conflict Minerals

This product does not contain any substances designated as "conflict minerals" such as tantalum, tin, gold or tungsten from the Democratic Republic of Congo or adjacent countries.