

Holders • for spring plungers

EH 22082.



Product Description

Holders are used to mount spring plungers, smooth, with collar (EH 22080) on the side.

Material

- Zinc die-cast, nickel-plated

Assembly

The left and right hand versions (picture 1 / picture 3) are attached using only one screw, and are also provided with an anti-turn locking device.

More information

References

Suitable for spring plungers, smooth, with collar and ball (EH 22080.)

Drawing

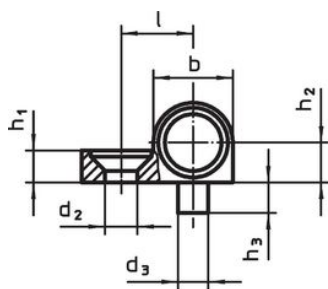

picture 1

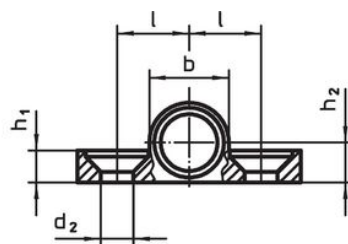

picture 2

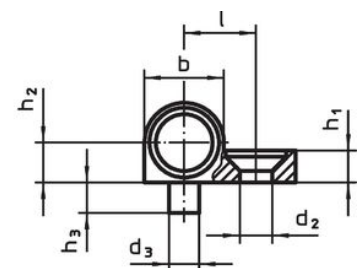

picture 3

Order information

| Dimensions | | | | | | | | Suitable screw |  | Art. No. |
|------------------------------|----------------|----------------|------|----------------|----------------|----------------|-------|----------------|---|----------------------------|
| d ₁ | d ₂ | d ₃ | b | h ₁ | h ₂ | h ₃ | l | [mm] | [g] | |
| | | -0.05 | | [mm] | ±0.05 | | ±0.05 | | | |
| left – picture 1 | | | | | | | | | | |
| 6 | 3.2 | 3 | 8.5 | 3.2 | 4.25 | 3 | 7.5 | M3 | 2.9 | 22082.0006 |
| 8 | 4.3 | 4 | 10.5 | 4.2 | 5.25 | 4 | 9.5 | M4 | 5.3 | 22082.0008 |
| two-sided – picture 2 | | | | | | | | | | |
| 6 | 3.2 | – | 8.5 | 3.2 | 4.25 | – | 7.5 | M3 | 3.5 | 22082.0106 |
| 8 | 4.3 | – | 10.5 | 4.2 | 5.25 | – | 9.5 | M4 | 6.5 | 22082.0108 |
| right – picture 3 | | | | | | | | | | |
| 6 | 3.2 | 3 | 8.5 | 3.2 | 4.25 | 3 | 7.5 | M3 | 2.8 | 22082.0206 |
| 8 | 4.3 | 4 | 10.5 | 4.2 | 5.25 | 4 | 9.5 | M4 | 5.2 | 22082.0208 |

Application example

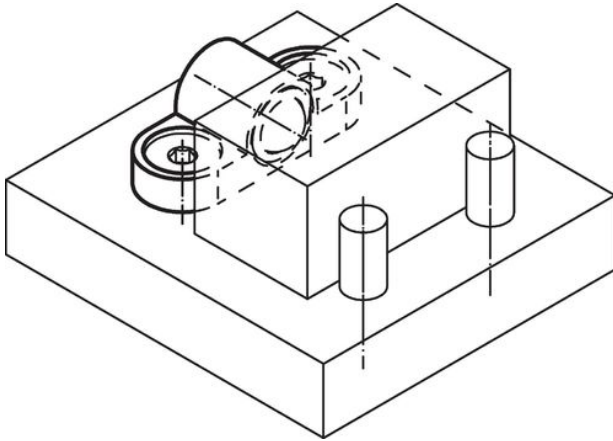

Compliance

RoHS compliant

Contains lead - compliant according to exceptions 6a / 6b / 6c.

Contains SVHC substances >0,1% w/w

Contains lead - SVHC list [REACH] as of 23.01.2024.

Contains Proposition 65 substances



Lead can cause cancer and reproductive harm from exposure
<https://www.P65Warnings.ca.gov/>

Free from Conflict Minerals

This product does not contain any substances designated as "conflict minerals" such as tantalum, tin, gold or tungsten from the Democratic Republic of Congo or adjacent countries.