

Connecting Elements • hydraulically operated, single acting with lifting-off

EH 1990.



Product Description

Material

- Steel, case-hardened, ground

More information

Further products

- Connecting Rings
- Coverings, for connecting elements

Drawing

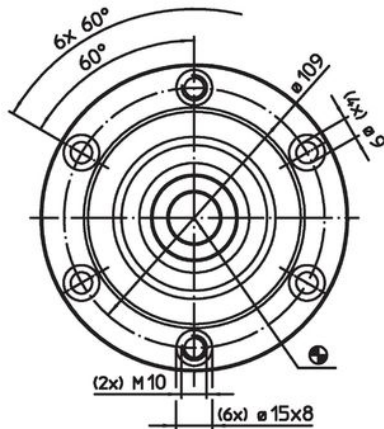
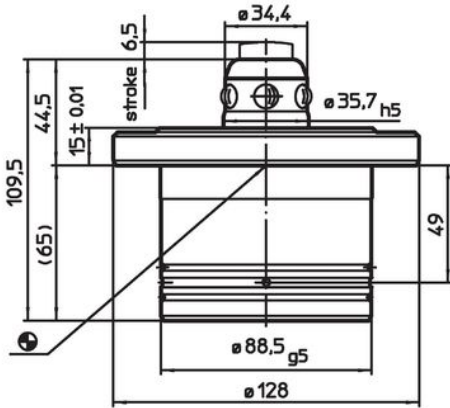

location hole
hydraulic connection

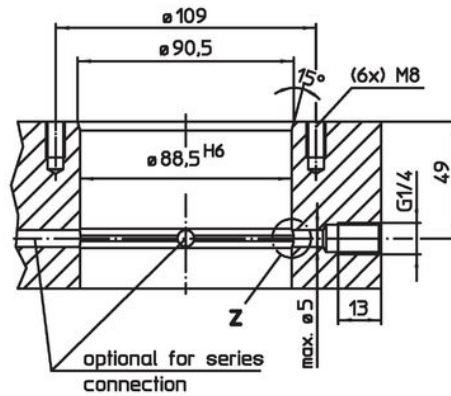
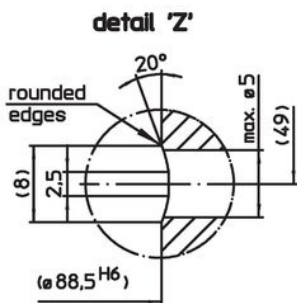

optional for series
connection

Order information

Holding force [N]	Centering accuracy < [mm]	Release pressure max. [bar]	 [kg]	Art. No.
20000	0.01	60 – 80	4	1990.080

Compliance

RoHS compliant

Compliant according to Directive 2011/65/EU and Directive 2015/863.

Does not contain SVHC substances

No SVHC substances with more than 0.1% w/w contained - SVHC list [REACH] as of 27.06.2024.

Does not contain Proposition 65 substances

No Proposition 65 substances included.

<https://www.P65Warnings.ca.gov/>

Free from Conflict Minerals

This product does not contain any substances designated as "conflict minerals" such as tantalum, tin, gold or tungsten from the Democratic Republic of Congo or adjacent countries.