

Jaw Sets for Five-Sided Machining

EH 1704.

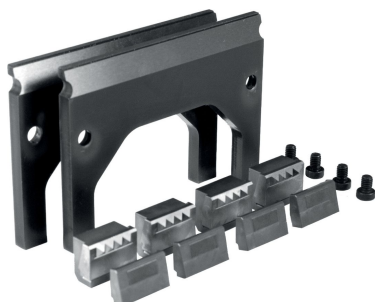

Product Description

- Pull-down elements suitable for clamping and pulling unmachined clamping surfaces down onto the guideway or onto the 90-mm support plates supplied
 - This way workpieces can be clamped almost exactly parallel to the guideway for machining
 - The direct contact to the support plates largely reduces vibrations in the workpiece
- Supplied in handycase consisting of:
- 4 x wedge adapters for five-sided machining jaw (Art. No. 1704.410)
 - 4 x wedge elements, four-point (Art. No. 1703.340)
 - 4 x wedge elements, microgripper (Art. No. 1703.350)
 - 2 x insertable plates ($h_1=90$ mm) (Art. No. 1704.520)
 - 20 x cheese-head screws M 6 x 8 (Art. No. 1704.600)

Material

- On request

Drawing

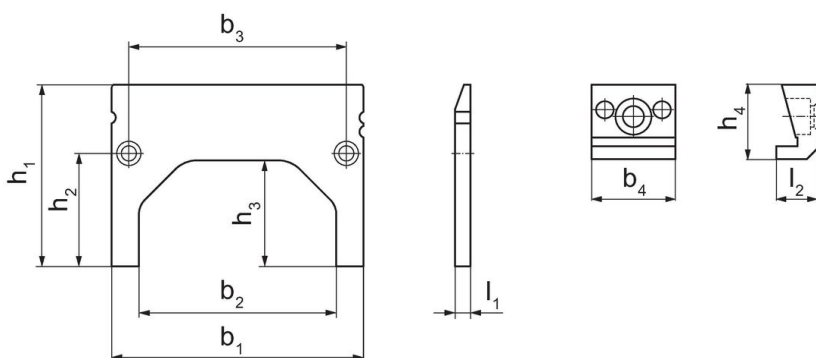

Order information

| Jaw width [mm] | Insertable plate | | | Dimensions | | | Wedge Adapter | | | [g] | Art. No. | |
|-------------------|------------------|-------|-------|------------|-------|-------|---------------|-------|-------|-------|----------|----------|
| | b_1 | b_2 | b_3 | l_1 | h_1 | h_2 | h_3 | b_4 | l_2 | | | h_4 |
| 125 | 125 | 98 | 108 | 7.6 | 90 | 56 | 53 | 24.15 | 11.8 | 21.45 | 1790 | 1704.300 |

Compliance

RoHS compliant

Compliant according to Directive 2011/65/EU and Directive 2015/863.

Does not contain SVHC substances

No SVHC substances with more than 0.1% w/w contained - SVHC list [REACH] as of 23.01.2024.

Does not contain Proposition 65 substances

No Proposition 65 substances included.

<https://www.P65Warnings.ca.gov/>

Free from Conflict Minerals

This product does not contain any substances designated as "conflict minerals" such as tantalum, tin, gold or tungsten from the Democratic Republic of Congo or adjacent countries.