

Supports for Clamping Bar

EH 1586.



Product Description

Material

- Tool steel, hardened

Drawing

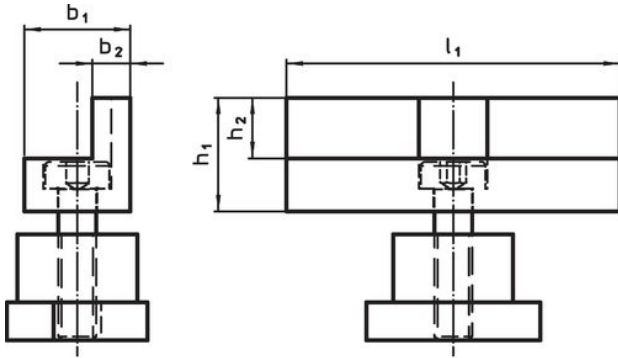

picture 1

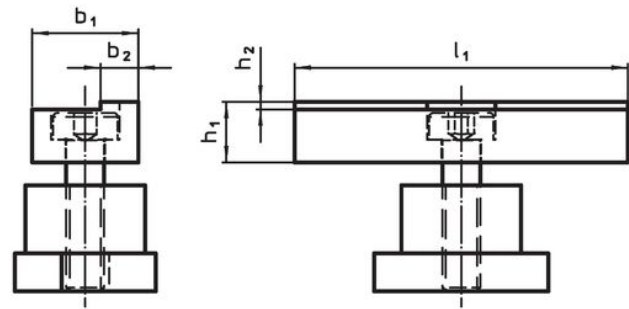

picture 2

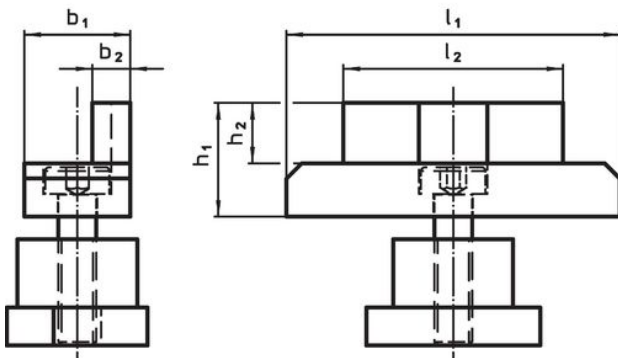

picture 3

Order information

Dimensions						 [g]	Art. No.
l_1	l_2	b_1	b_2	h_1 ± 0.01	h_2		
high – picture 1							
44	–	14	5	15	8	72	1586.200
low – picture 2							
44	–	14	5	8	1	60	1586.202
high, width shortened – picture 3							
44	29	14	5	15	8	64	1586.201

Compliance

RoHS compliant

Compliant according to Directive 2011/65/EU and Directive 2015/863.

Does not contain SVHC substances

No SVHC substances with more than 0.1% w/w contained - SVHC list [REACH] as of 27.06.2024.

Does not contain Proposition 65 substances

No Proposition 65 substances included.

<https://www.P65Warnings.ca.gov/>

Free from Conflict Minerals

This product does not contain any substances designated as "conflict minerals" such as tantalum, tin, gold or tungsten from the Democratic Republic of Congo or adjacent countries.