

Stop Angles

EH 1520.400 - EH 1621.700



Product Description

Material

- Grey cast iron, phosphatized, ground

Drawing

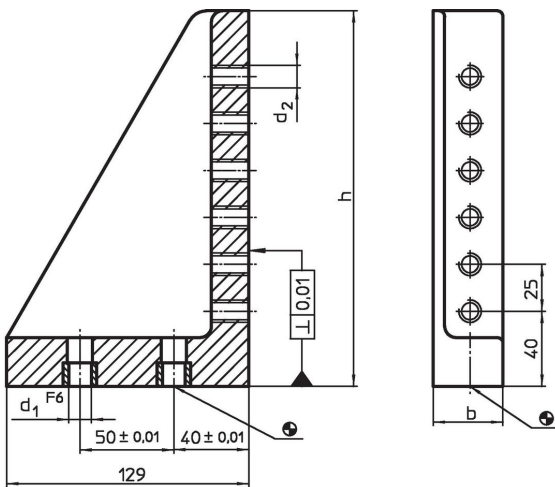

Order information

System	Dimensions				Number of threads	 [g]	Art. No.
	b	h	d ₁	d ₂			
L12	37	140	12	M12	4	1688	1520.400
L12	37	200	12	M12	6	2167	1520.500
L16	66	140	16	M16	4	3121	1621.600
L16	66	200	16	M16	6	3642	1621.700

Compliance

RoHS compliant

Compliant according to Directive 2011/65/EU and Directive 2015/863.

Does not contain SVHC substances

No SVHC substances with more than 0.1% w/w contained - SVHC list [REACH] as of 27.06.2024.

Does not contain Proposition 65 substances

No Proposition 65 substances included.

<https://www.P65Warnings.ca.gov/>

Free from Conflict Minerals

This product does not contain any substances designated as "conflict minerals" such as tantalum, tin, gold or tungsten from the Democratic Republic of Congo or adjacent countries.