

Base Plates

EH 1501.300 - EH 1501.500



Product Description

Material

- Grey cast iron, ground

More information

Notes

Customized design on request.

Drawing

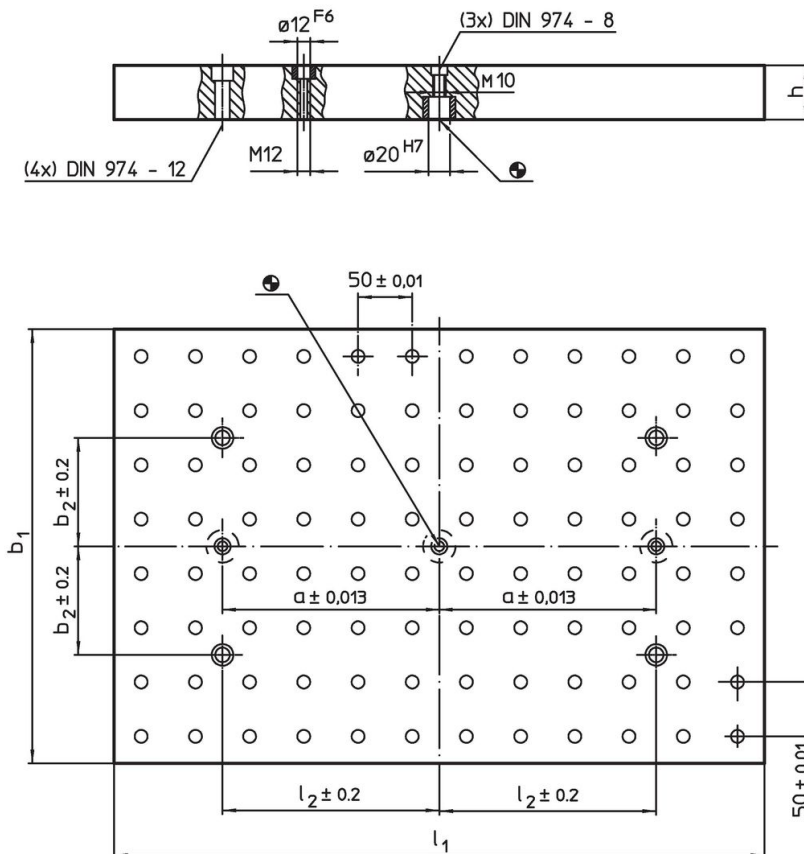

Order information

System	$b_1 \times l_1$	Dimensions				Number of hole rows	 [kg]	Art. No.
		h ± 0.02	a	l_2	b_2			
[mm]								
L12	300 x 400	40	150	150	100	6 x 8	34	1501.300
L12	400 x 600	40	200	200	100	8 x 12	69	1501.500

Application example

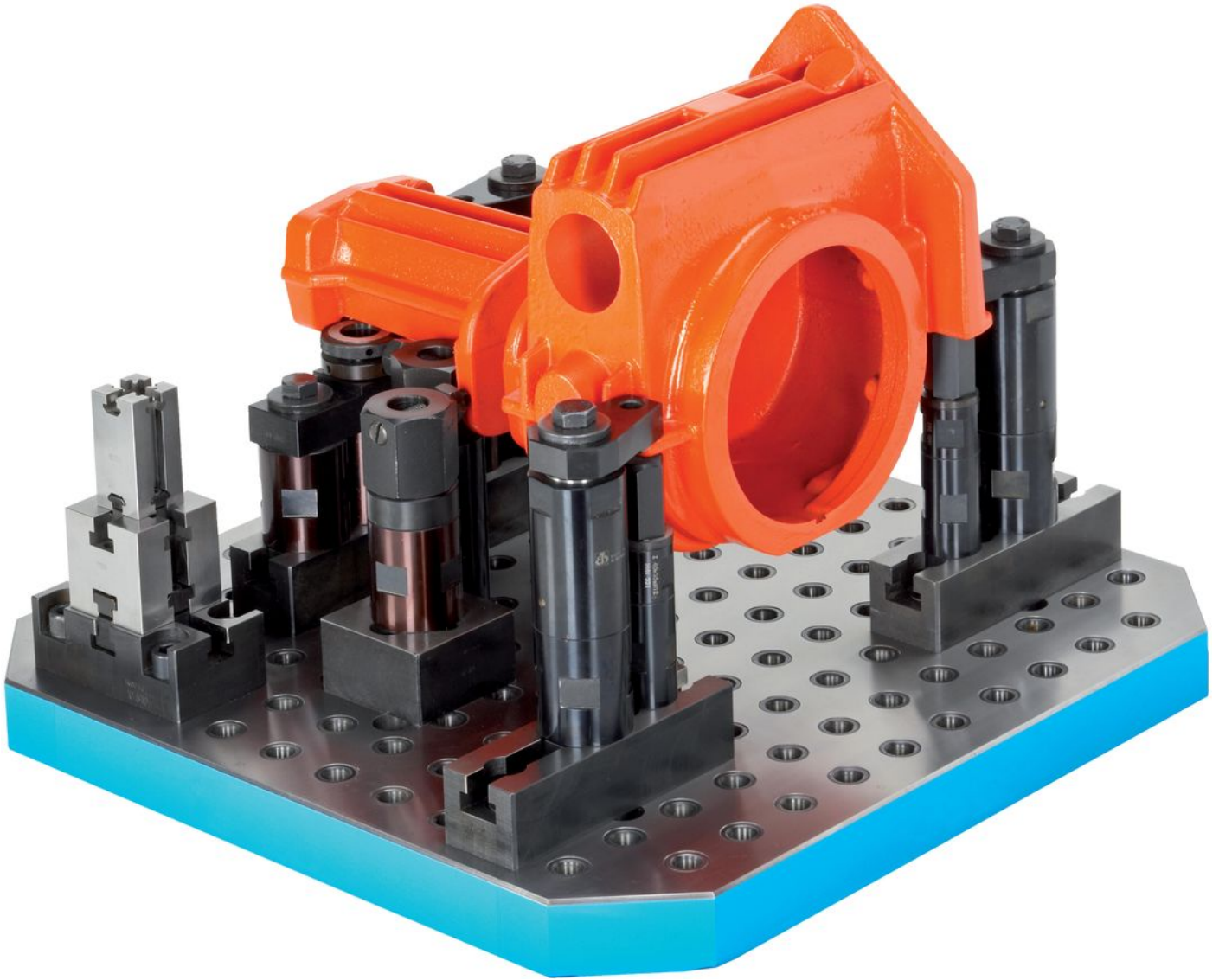



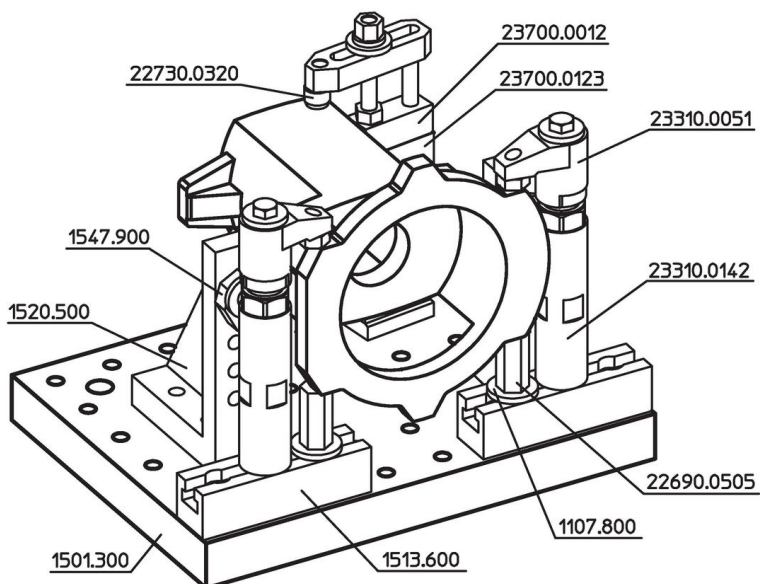
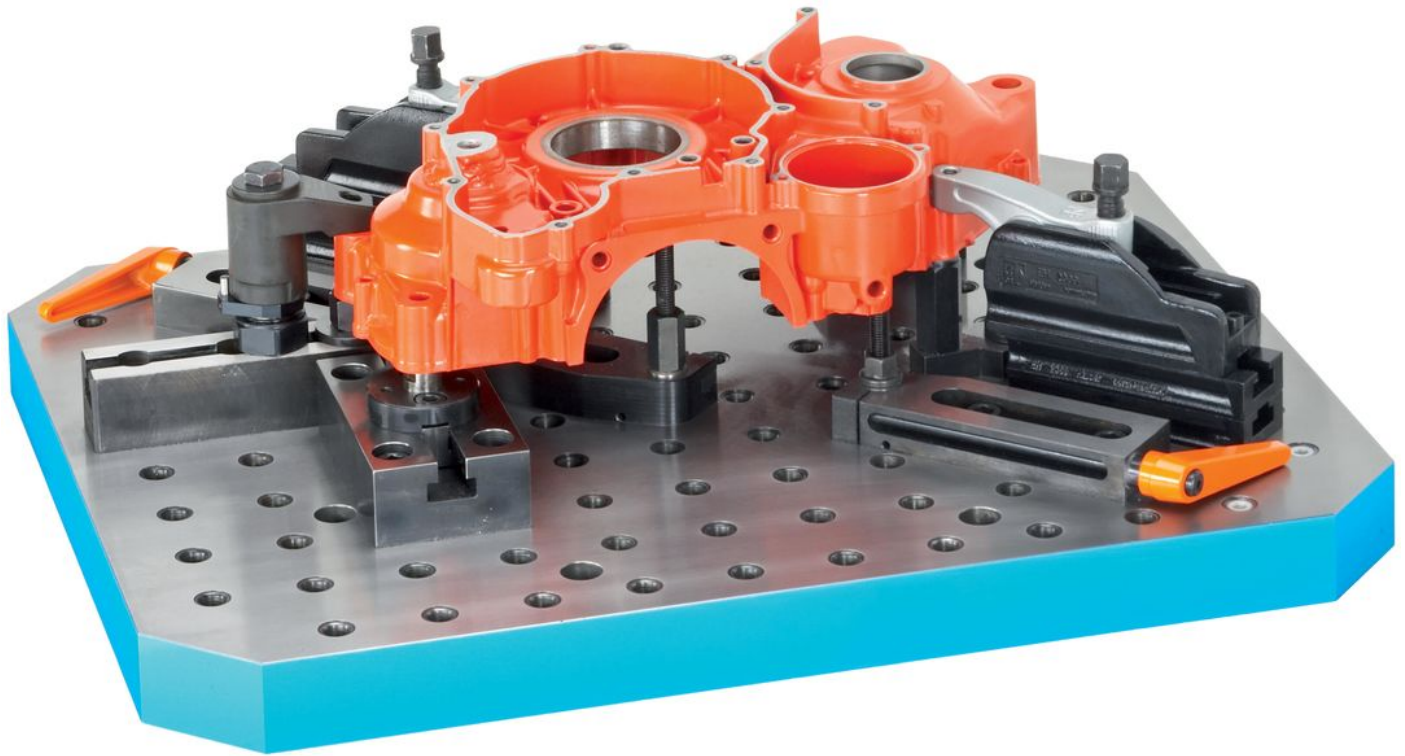

Compliance

RoHS compliant

Compliant according to Directive 2011/65/EU and Directive 2015/863.

Does not contain SVHC substances

No SVHC substances with more than 0.1% w/w contained - SVHC list [REACH] as of 27.06.2024.

Does not contain Proposition 65 substances

No Proposition 65 substances included.
<https://www.P65Warnings.ca.gov/>

Free from Conflict Minerals

This product does not contain any substances designated as "conflict minerals" such as tantalum, tin, gold or tungsten from the Democratic Republic of Congo or adjacent countries.