

## Fixed Drilling Supports • adjustable

EH 1163.000 - EH 1163.300



### Product Description

#### Material

- Steel, case-hardened, ground

### Drawing

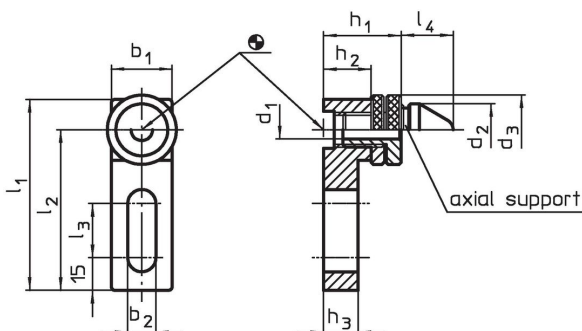

### Order information

System	b <sub>1</sub>	b <sub>2</sub>	d <sub>1</sub>	d <sub>2</sub>	d <sub>3</sub>	Dimensions							[g]	Art. No.
						l <sub>1</sub>	l <sub>2</sub>	l <sub>3</sub>	l <sub>4</sub>	h <sub>1</sub>	h <sub>2</sub>	h <sub>3</sub>		
V70/L12	28	13	9.9	24	32	88	74	25	24	36 – 45	22	16	381	1163.000
V70/L12	38	13	16.9	30	42	108	89	40	27	44 – 54	26	20	800	1163.100
V70/L12	48	17	24.8	45	55	108	84	25	27	54 – 68	32	26	1391	1163.200
V70/L12	58	17	34.9	52	68	128	99	40	27	68 – 82	44	38	3000	1163.300

### Compliance

#### RoHS compliant

Compliant according to Directive 2011/65/EU and Directive 2015/863.

#### Does not contain SVHC substances

No SVHC substances with more than 0.1% w/w contained - SVHC list [REACH] as of 27.06.2024.

#### Does not contain Proposition 65 substances

No Proposition 65 substances included.

<https://www.P65Warnings.ca.gov/>

#### Free from Conflict Minerals

This product does not contain any substances designated as "conflict minerals" such as tantalum, tin, gold or tungsten from the Democratic Republic of Congo or adjacent countries.