

Support Clamping Bars

EH 1047.800 - EH 1147.800



Product Description

Material

- Steel, case-hardened, ground

Drawing

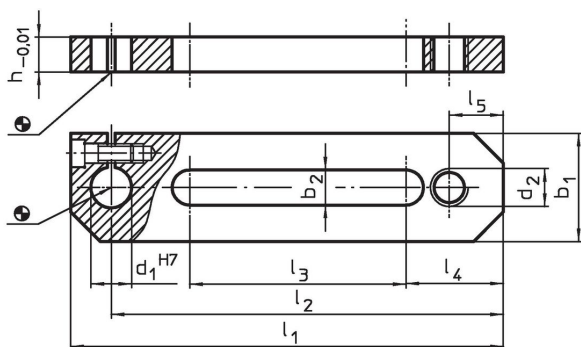

Order information

System	Dimensions										Art. No.	
	b ₁	b ₂	d ₁	d ₂	h	l ₁	l ₂	l ₃	l ₄	l ₅		[g]
V40	25	8.5	10	M 8	15	100	88	45	23	12	214	1047.800
V70	40	13.0	15	M12	13	160	145	80	36	20	484	1147.800

Compliance

RoHS compliant

Compliant according to Directive 2011/65/EU and Directive 2015/863.

Does not contain SVHC substances

No SVHC substances with more than 0.1% w/w contained - SVHC list [REACH] as of 23.01.2024.

Does not contain Proposition 65 substances

No Proposition 65 substances included.

<https://www.P65Warnings.ca.gov/>

Free from Conflict Minerals

This product does not contain any substances designated as "conflict minerals" such as tantalum, tin, gold or tungsten from the Democratic Republic of Congo or adjacent countries.