

## Base Plates

EH 1000.400 - EH 1000.500



### Product Description

#### Material

- Steel, hardened, ground

#### More information

#### Notes

Special types on request.

### Drawing

1000.400

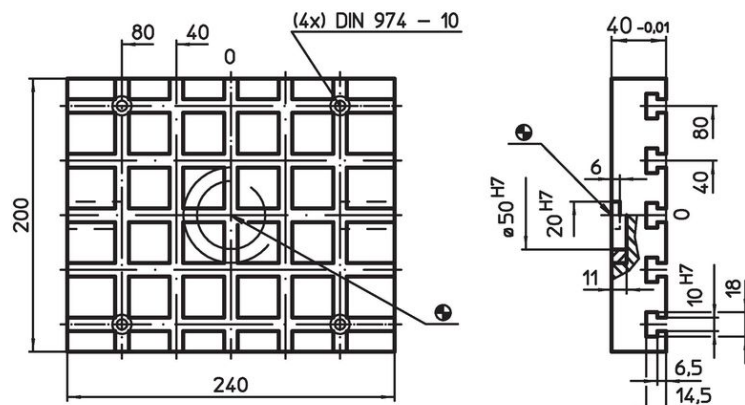

1000.500

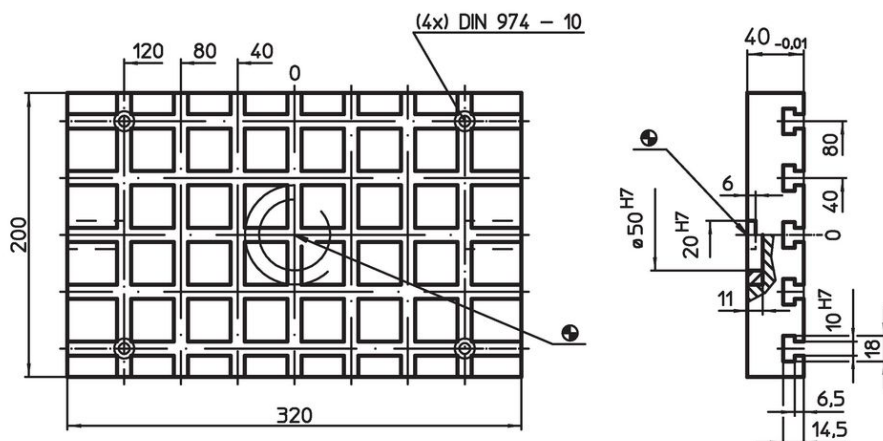

Slot spacing  $40 \pm 0,01$ .

### Order information

System	Dimensions				y [mm]	Number of T-slots	 [kg]	Art. No.
	b <sub>1</sub>	b <sub>2</sub>	l <sub>1</sub>	l <sub>2</sub>				
V40	200	80	240	80	10	5 x 5	13	1000.400
V40	200	80	320	40	10	5 x 7	14	1000.500

Application example

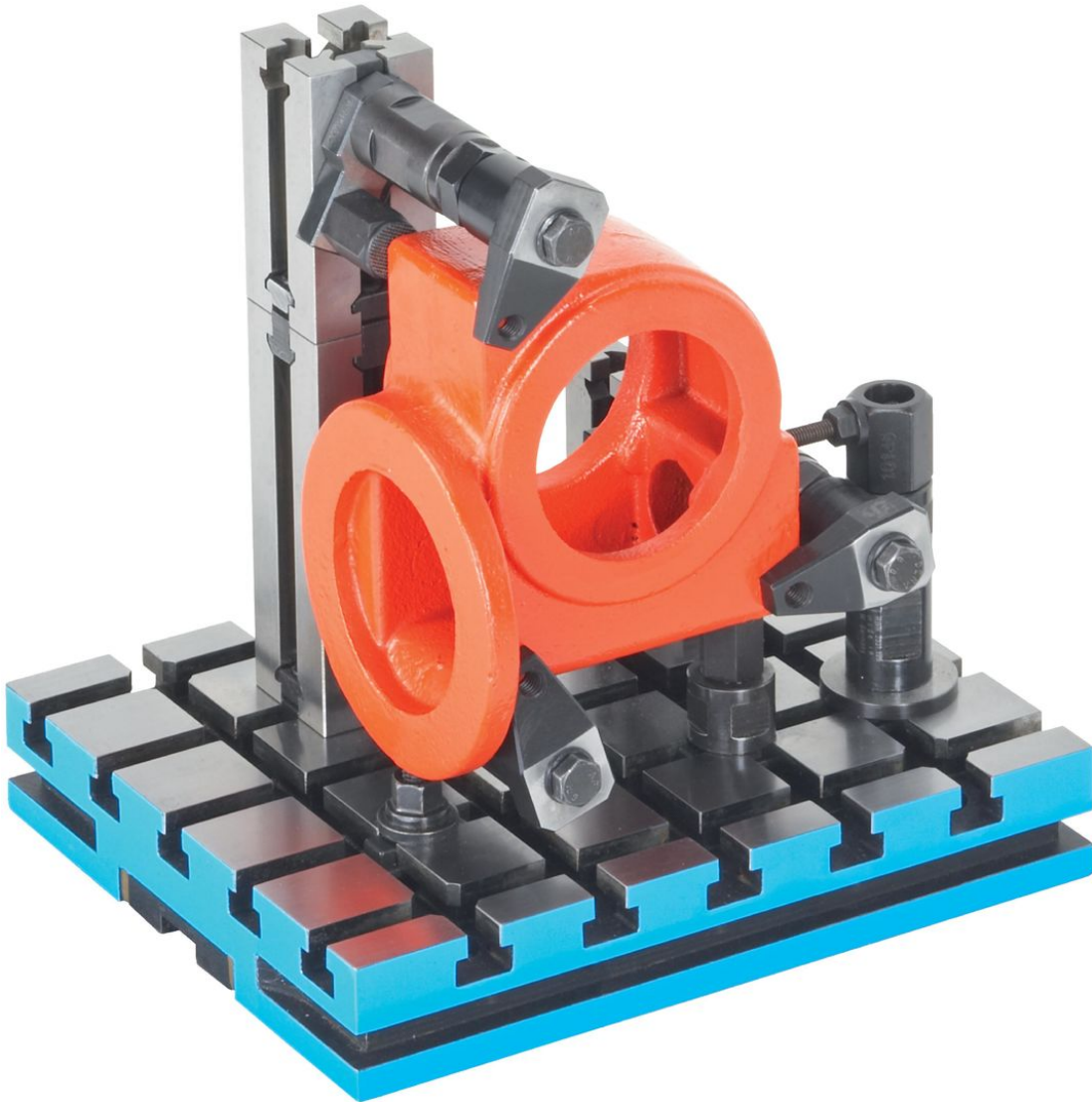



## Compliance

### RoHS compliant

Contains lead - compliant according to exceptions 6a / 6b / 6c.

### Contains SVHC substances >0,1% w/w

Contains lead - SVHC list [REACH] as of 27.06.2024.

### Contains Proposition 65 substances



Lead can cause cancer and reproductive harm from exposure

<https://www.P65Warnings.ca.gov/>

### Free from Conflict Minerals

This product does not contain any substances designated as "conflict minerals" such as tantalum, tin, gold or tungsten from the Democratic Republic of Congo or adjacent countries.