

## Hinges

25165.0240



### Product Description

The different versions cover many applications that require a low load.

These metal hinges are characterised by their simple design and the different versions:

- without bores
- with bores
- with bores for countersunk screws

The version without bores can be assembled by welding or by inserting a specific drilling pattern.

### Material

#### Body

- Stainless steel 1.4301

#### Axis

- Stainless steel 1.4301

### Drawing

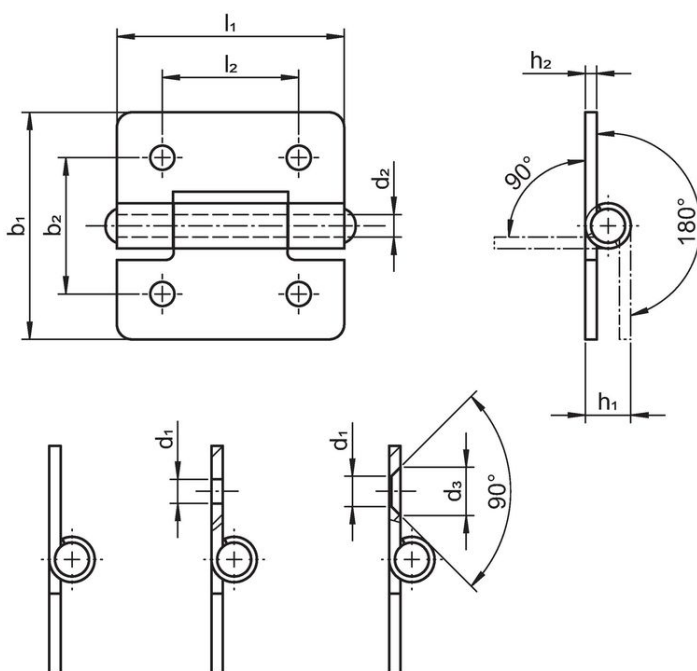

picture 1    picture 2    picture 3

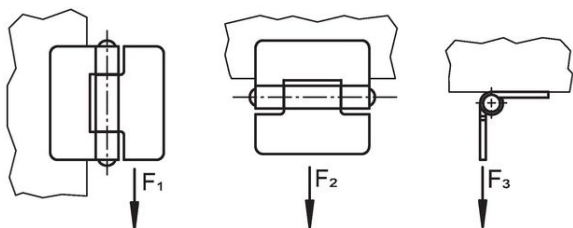

### Order information

b <sub>1</sub>	l <sub>1</sub>	b <sub>2</sub>	Dimensions			h <sub>1</sub>	h <sub>2</sub>	l <sub>2</sub>	Holding force			[g]	Art. No.	
			d <sub>1</sub>	d <sub>2</sub>	d <sub>3</sub>				F <sub>1</sub>	F <sub>2</sub>	F <sub>3</sub>			
[mm]									~	~	~			
with bores for countersunk screws – picture 3, Stainless steel														
50	50	30	4	6	8.3	10	2	30	2500	2000	1000	61	25165.0240	

## Compliance

### RoHS compliant

Compliant according to Directive 2011/65/EU and Directive 2015/863.

### Does not contain SVHC substances

No SVHC substances with more than 0.1% w/w contained - SVHC list [REACH] as of 23.01.2024.

### Does not contain Proposition 65 substances

No Proposition 65 substances included.

<https://www.P65Warnings.ca.gov/>

### Free from Conflict Minerals

This product does not contain any substances designated as "conflict minerals" such as tantalum, tin, gold or tungsten from the Democratic Republic of Congo or adjacent countries.