

Hinges • adjustable  
25161.0145

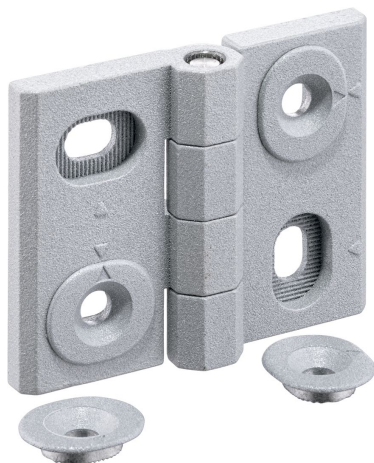

Product Description

Adjustable hinges can be positioned horizontally or vertically by moving the adjusting bushings in a form-fit and finely adjusted manner.

Material

Body

- Zinc die-cast, plastic coated, silver, similar to RAL 9006, matt structure

Axis

- Stainless Steel

Drawing

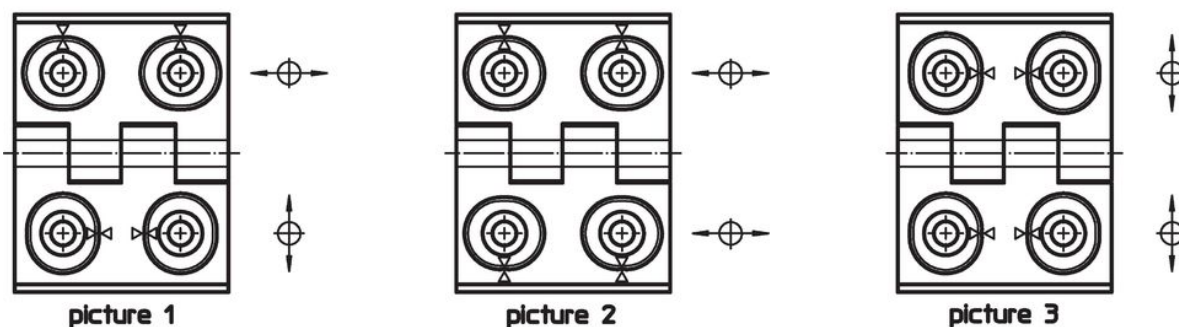
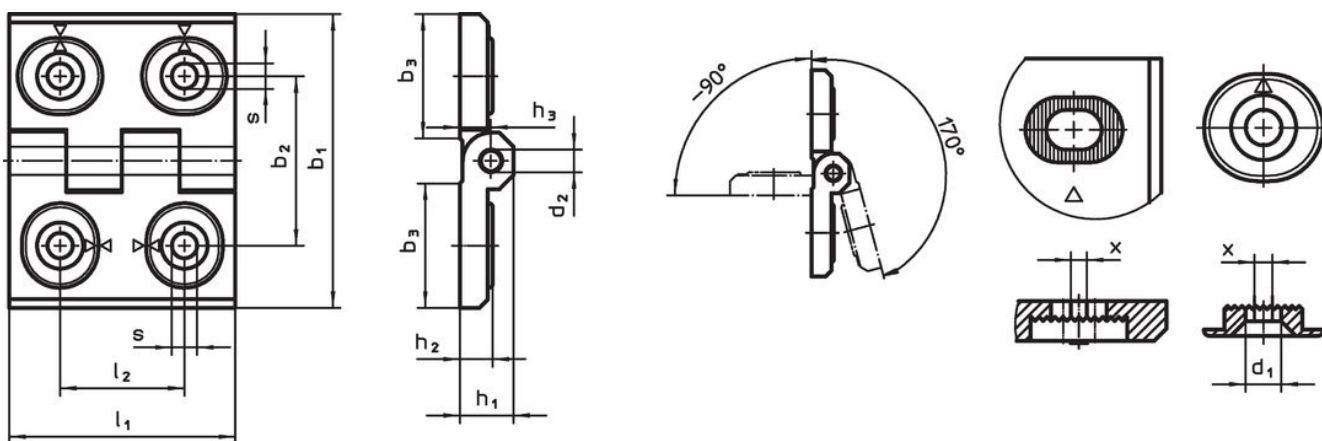

Order information

Dimensions											Art. No.	
b <sub>1</sub>	l <sub>1</sub>	b <sub>2</sub>	b <sub>3</sub>	d <sub>1</sub>	d <sub>2</sub>	h <sub>1</sub>	h <sub>2</sub>	h <sub>3</sub>	l <sub>2</sub>	x		[g]
adjustable in height and width – picture 1, Zinc die-cast, silver												
60	76	42	33.5	6.5	8	15	9	8.5	34	1	260	25161.0145

## Compliance

### RoHS compliant

Compliant according to Directive 2011/65/EU and Directive 2015/863.

### Does not contain SVHC substances

No SVHC substances with more than 0.1% w/w contained - SVHC list [REACH] as of 27.06.2024.

### Does not contain Proposition 65 substances

No Proposition 65 substances included.

<https://www.P65Warnings.ca.gov/>

### Free from Conflict Minerals

This product does not contain any substances designated as "conflict minerals" such as tantalum, tin, gold or tungsten from the Democratic Republic of Congo or adjacent countries.