

Stops · for hinges

25160.0815



Product Description

Stops are used in order to restrict the hinge's pivot angle. The component also acts as a damping stop element.

Material

Holding plate

- Steel investment casting, galvanised, plastic coated, similar to RAL 9005, black, structural matt

Stop

- NBR

Assembly

The stop is screwed onto the hinge.

Drawing

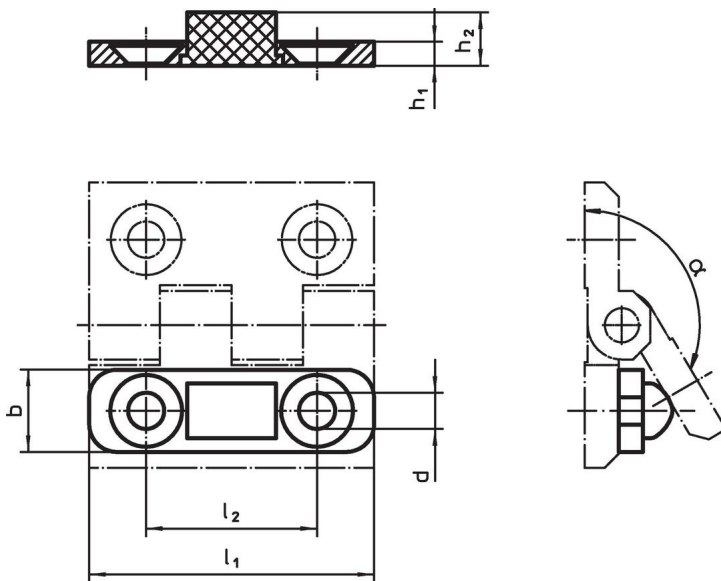

Order information

Dimensions						α	🌡️	📦	Art. No.
l_1	h_1	b	d	h_2	l_2	~	max.	[g]	
[mm]							[°C]		
60	5	18	8.3	10.9	36	150°	120	22	25160.0815

Compliance

RoHS compliant

Compliant according to Directive 2011/65/EU and Directive 2015/863.

Does not contain SVHC substances

No SVHC substances with more than 0.1% w/w contained - SVHC list [REACH] as of 23.01.2024.

Does not contain Proposition 65 substances

No Proposition 65 substances included.
<https://www.P65Warnings.ca.gov/>

Free from Conflict Minerals

This product does not contain any substances designated as "conflict minerals" such as tantalum, tin, gold or tungsten from the Democratic Republic of Congo or adjacent countries.