

Rubber Endstop Buffers · cylindrical

25150.1442



Product Description

To be used as an elastic end-stop, bearing foot etc.
The hardness is $55 \pm 5^\circ$ shore A. Further shore hardnesses ($40 \pm 5^\circ$ shore A and $70 \pm 5^\circ$ shore A) on request.

Material

Support washer

- Stainless steel 1.4301

Body

- Rubber natural caoutchouc (NR), black

Screw

- Stainless steel 1.4301

More information

Further products

- Support Legs, impact cushioning

Drawing

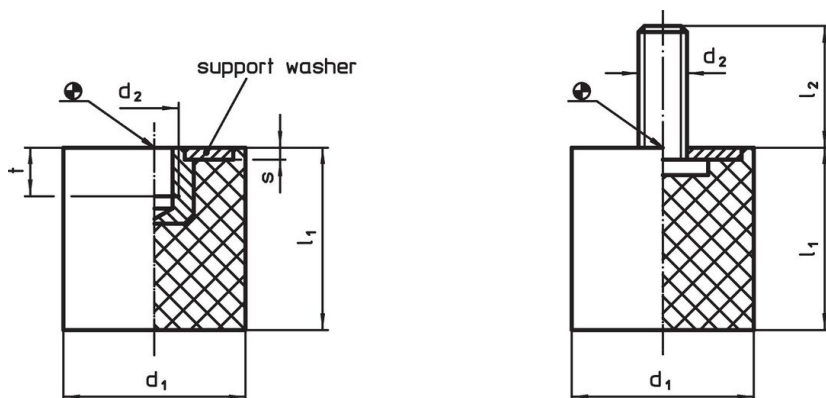

picture 1

picture 2

Order information

Dimensions					Spring rate R ~ [N/mm]	Load capacity max. [N]	Spring range ~ [mm]	Spring range		Weight [g]	Art. No.
d ₁	l ₁	d ₂ [mm]	l ₂	s				min.	max.		
with screw – picture 2, Stainless steel											
40	25	M8	23	2	247	1546	6.25	-30	80	60	25150.1442

Application example

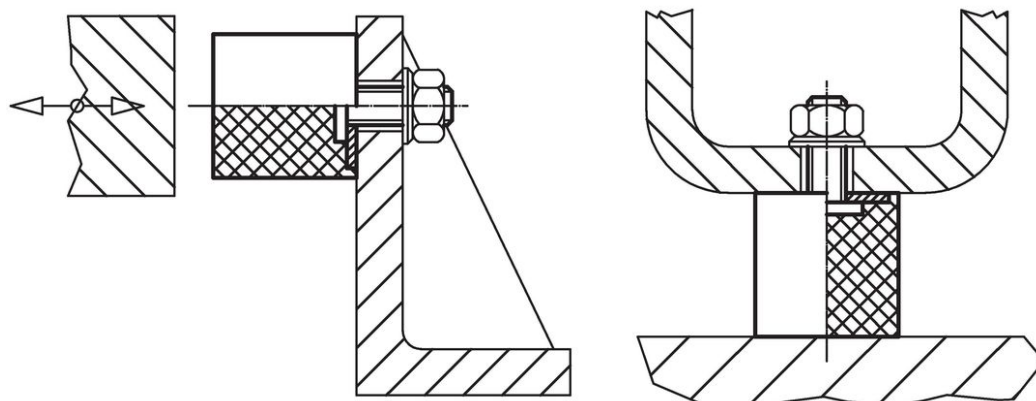

Compliance

RoHS compliant

Compliant according to Directive 2011/65/EU and Directive 2015/863.

Does not contain SVHC substances

No SVHC substances with more than 0.1% w/w contained - SVHC list [REACH] as of 27.06.2024.

Does not contain Proposition 65 substances

No Proposition 65 substances included.

<https://www.P65Warnings.ca.gov/>

Free from Conflict Minerals

This product does not contain any substances designated as "conflict minerals" such as tantalum, tin, gold or tungsten from the Democratic Republic of Congo or adjacent countries.