

Rubber Endstop Buffers · low structure

25150.1232



Product Description

For elastic, damping, and noise-reducing bearings. They also protect the surfaces. The rubber endstop buffers can also be used as spacers and foot ends. Hardness is 70 ±5° Shore A.

Material

Support washer

- Steel, zinc-plated by galvanization, passivated

Body

- NBR

Drawing

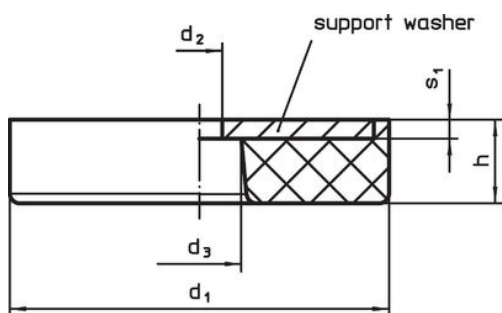

picture 1

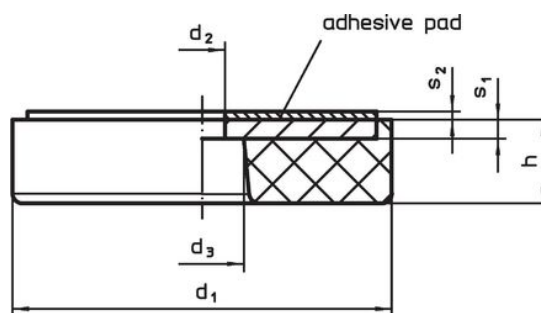

picture 2

Order information

Dimensions						Spring rate R	Load capacity max.	Spring range	Temperature		Weight [g]	Art. No.
d ₁	h	d ₂ +0.5	d ₃ +0.5	s ₁	s ₂				min.	max.		
[mm]						[N/mm]	[N]	[mm]	[°C]		[g]	
with through-bore and adhesive pad – picture 2												
32	4	5	9	2	1.1	1680	1680	1	-30	120	13	25150.1232

Application example



Compliance

RoHS compliant

Contains lead - compliant according to exceptions 6a / 6b / 6c.

Contains SVHC substances >0,1% w/w

Contains lead - SVHC list [REACH] as of 23.01.2024.

Contains Proposition 65 substances



Lead can cause cancer and reproductive harm from exposure
<https://www.P65Warnings.ca.gov/>

Free from Conflict Minerals

This product does not contain any substances designated as "conflict minerals" such as tantalum, tin, gold or tungsten from the Democratic Republic of Congo or adjacent countries.