

## Height-Adjusting Elements • high

25120.0146



### Product Description

For levelling of machines and installations.  
For vertical adjustment, the self-locking height-adjusting elements are fitted with a fine-pitch thread. All elements have a throughgoing bore for fastening purposes. A turn-out lock serves as height limit for the maximum adjustment height.

### Material

- Heat-treated steel, zinc-plated by galvanization, chromalized

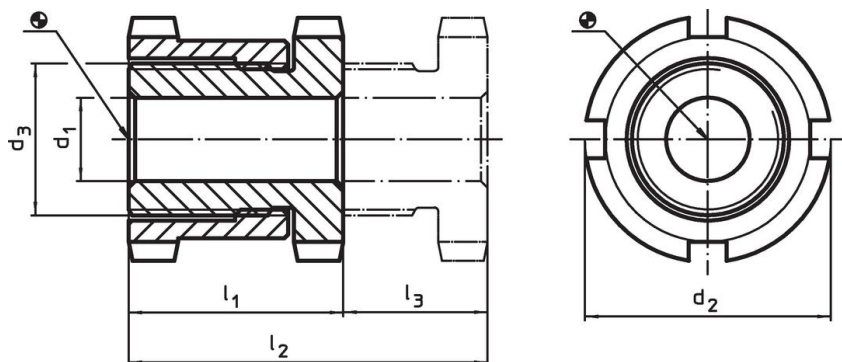

### Drawing



### Order information

$d_1$	$d_2$	Dimensions $d_3$ [mm]	$l_1$ ~	$l_2$ ~	Stroke $l_3$ ~ [mm]	For screw [mm]	Load capacity for static load max. [kN]	Load capacity max. [kN]	 [g]	Art. No.
33	70	M50 x 1,5	66	106	40	M30	330	53	1167	25120.0146

### Accessories

	For height adjusting element size $d_2$ [mm]	Dimensions of sickle spanner DIN 1810, form A [mm]	 [g]	Art. No.
<b>sickle spanner for vertical adjustment</b>				
	70	68 – 75	253	25120.0985

## Application example



## Compliance

### RoHS compliant

Compliant according to Directive 2011/65/EU and Directive 2015/863.

### Does not contain SVHC substances

No SVHC substances with more than 0.1% w/w contained - SVHC list [REACH] as of 23.01.2024.

### Does not contain Proposition 65 substances

No Proposition 65 substances included.

<https://www.P65Warnings.ca.gov/>

### Free from Conflict Minerals

This product does not contain any substances designated as "conflict minerals" such as tantalum, tin, gold or tungsten from the Democratic Republic of Congo or adjacent countries.