

## Set Collars

25069.0330



### Product Description

Set collars with universal applicability, e.g. as a fixed stop.  
Set collars with strong clamping force.

### Material

#### Screw

- Stainless steel

#### Set collar

- Stainless steel 1.4404

### Drawing

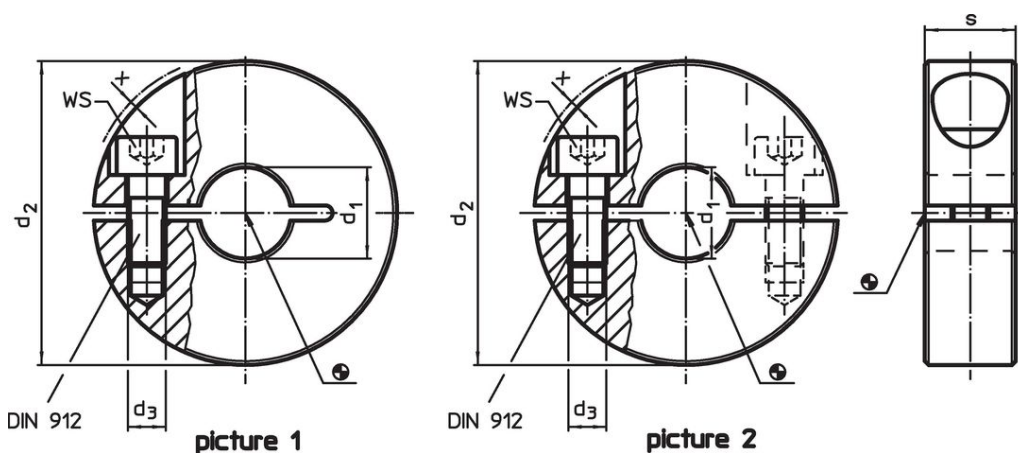

### Order information

d <sub>1</sub> H10	d <sub>2</sub>	Dimensions			WS [mm]	[g]	Art. No.
		d <sub>3</sub> [mm]	s	x			
divided – picture 2, Stainless steel							
30	55	M6	15	0.5	5	153	25069.0330

## Application example



## Compliance

### RoHS compliant

Compliant according to Directive 2011/65/EU and Directive 2015/863.

### Does not contain SVHC substances

No SVHC substances with more than 0.1% w/w contained - SVHC list [REACH] as of 23.01.2024.

### Does not contain Proposition 65 substances

No Proposition 65 substances included.

<https://www.P65Warnings.ca.gov/>

### Free from Conflict Minerals

This product does not contain any substances designated as "conflict minerals" such as tantalum, tin, gold or tungsten from the Democratic Republic of Congo or adjacent countries.