

## High Knurled Thumb Screws • DIN 464

24790.0140



### Product Description

All knurled screws are one-piece manufactured. Contrary to the Official Standard Sheet, they all have a thread up to the head, but no recess at the thread end.

### Material

- Steel, blackened, quality 5.8

### More information

### Notes

Knurling pitch and knurling depth may differ from DIN.

### Drawing

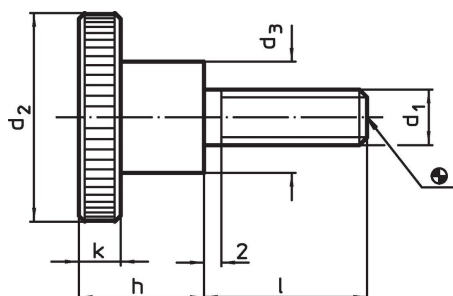

### Order information

Dimensions						Art. No.
$d_1$	$l$	$d_2$	$d_3$	$h$	$k$	
[mm]						[g]
Steel						
M6	25	24	12	15	5	30
						24790.0140

### Application example

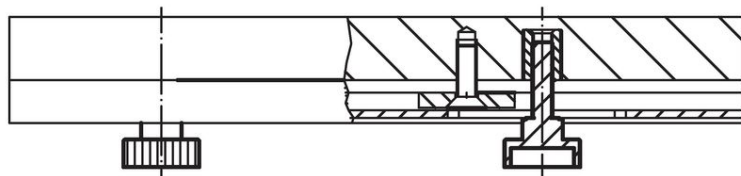
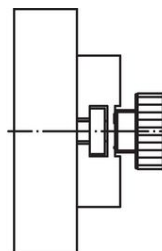
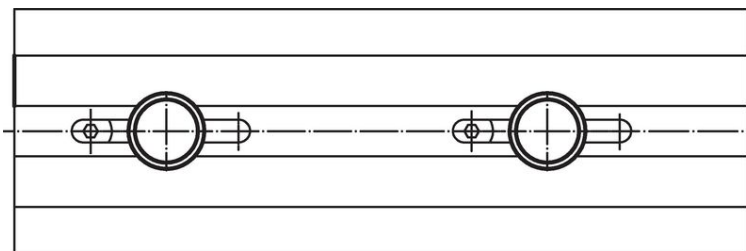

## Compliance

### RoHS compliant

Contains lead - compliant according to exceptions 6a / 6b / 6c.

### Contains SVHC substances >0,1% w/w

Contains lead - SVHC list [REACH] as of 23.01.2024.

### Contains Proposition 65 substances



Lead can cause cancer and reproductive harm from exposure  
<https://www.P65Warnings.ca.gov/>

### Free from Conflict Minerals

This product does not contain any substances designated as "conflict minerals" such as tantalum, tin, gold or tungsten from the Democratic Republic of Congo or adjacent countries.