

High Knurled Nuts • DIN 466

24780.0380



Product Description

Material

- Steel, zinc-plated by galvanization, quality 5

More information

Notes

Knurling pitch and knurling depth may differ from DIN.

Drawing

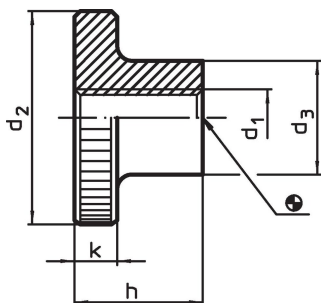

Order information

d ₁	d ₂	Dimensions			k	[g]	Art. No.
		d ₃	h	[mm]			
Steel	M8	30	16	18	6	42	24780.0380

Application example

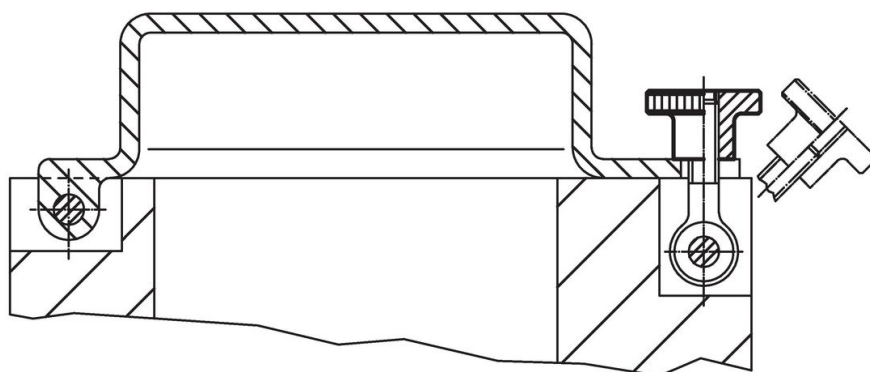

Compliance

RoHS compliant

Compliant according to Directive 2011/65/EU and Directive 2015/863.

Does not contain SVHC substances

No SVHC substances with more than 0.1% w/w contained - SVHC list [REACH] as of 23.01.2024.

Does not contain Proposition 65 substances

No Proposition 65 substances included.

<https://www.P65Warnings.ca.gov/>

Free from Conflict Minerals

This product does not contain any substances designated as "conflict minerals" such as tantalum, tin, gold or tungsten from the Democratic Republic of Congo or adjacent countries.