

High Knurled Nuts • DIN 466

24780.0300



Product Description

Material

- Stainless steel 1.4301, dull blasted

More information

Notes

Knurling pitch and knurling depth may differ from DIN.

Drawing

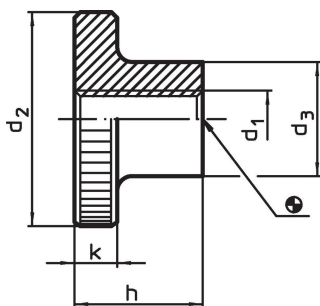

Order information

Dimensions					Art. No.
d ₁	d ₂	d ₃	h	k	
[mm]					[g]
Stainless steel					
M10	36	20	23	8	85
					24780.0300

Application example



Compliance

RoHS compliant

Compliant according to Directive 2011/65/EU and Directive 2015/863.

Does not contain SVHC substances

No SVHC substances with more than 0.1% w/w contained - SVHC list [REACH] as of 23.01.2024.

Does not contain Proposition 65 substances

No Proposition 65 substances included.

<https://www.P65Warnings.ca.gov/>

Free from Conflict Minerals

This product does not contain any substances designated as "conflict minerals" such as tantalum, tin, gold or tungsten from the Democratic Republic of Congo or adjacent countries.