

## Flat Knurled Thumb Screws • DIN 653

24770.0176



### Product Description

All knurled screws are one-piece manufactured with thread up to the head (DIN-designation A).

### Material

- Steel, blackened, quality 5.8

### More information

#### Notes

Knurling pitch and knurling depth may differ from DIN.

### Drawing

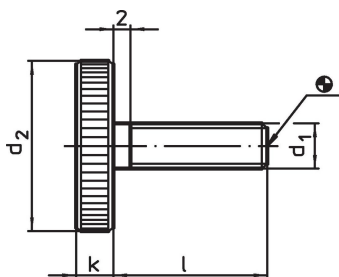

### Order information

d <sub>1</sub>	Dimensions		d <sub>2</sub>	k	[g]	Art. No.
	l	[mm]				
Steel						
M10	30		36	8	76	24770.0176

### Compliance

#### RoHS compliant

Contains lead - compliant according to exceptions 6a / 6b / 6c.

#### Contains SVHC substances >0,1% w/w

Contains lead - SVHC list [REACH] as of 23.01.2024.

#### Contains Proposition 65 substances



Lead can cause cancer and reproductive harm from exposure  
<https://www.P65Warnings.ca.gov/>

#### Free from Conflict Minerals

This product does not contain any substances designated as "conflict minerals" such as tantalum, tin, gold or tungsten from the Democratic Republic of Congo or adjacent countries.