

## Star Grip Screws • plastic

24750.0412



### Product Description

#### Material

##### Cap

- Thermoplastic PA, orange similar to RAL 2004

##### Handle

- Thermoplastic PA 6, black similar to RAL 9005

##### Screw

- Stainless steel

### More information

#### Notes

Special types, e.g. differing threads or thread lengths, on request.

### Drawing

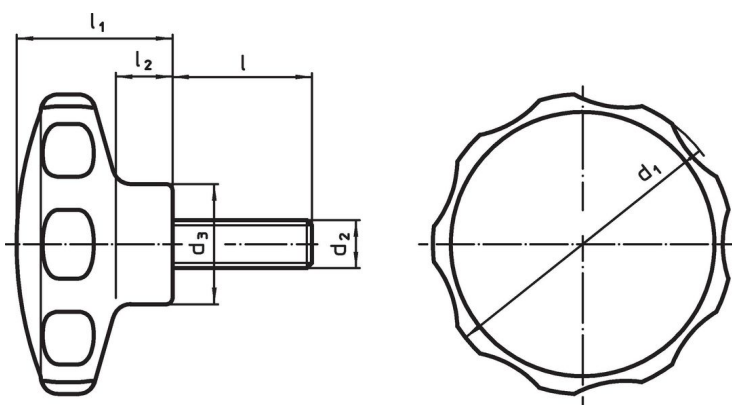

### Order information

Dimensions							min.	max.	[g]	Art. No.
d <sub>1</sub>	d <sub>2</sub>	l	d <sub>3</sub>	l <sub>1</sub>	l <sub>2</sub>	[mm]				
orange										
62	M8	23	22	35	13		-30	80	41	24750.0412

## Application example



## Compliance

### RoHS compliant

Compliant according to Directive 2011/65/EU and Directive 2015/863.

### Does not contain SVHC substances

No SVHC substances with more than 0.1% w/w contained - SVHC list [REACH] as of 23.01.2024.

### Does not contain Proposition 65 substances

No Proposition 65 substances included.

<https://www.P65Warnings.ca.gov/>

### Free from Conflict Minerals

This product does not contain any substances designated as "conflict minerals" such as tantalum, tin, gold or tungsten from the Democratic Republic of Congo or adjacent countries.