

## Star Grips · plastic

24750.0061



### Product Description

#### Material

##### Cap

- Thermoplastic PA, white similar to RAL 9019

##### Handle

- Thermoplastic PA 6, black similar to RAL 9005

##### Threaded bushing

- Stainless steel

#### More information

##### Notes

Special types, e.g. differing threads, on request.

### Drawing

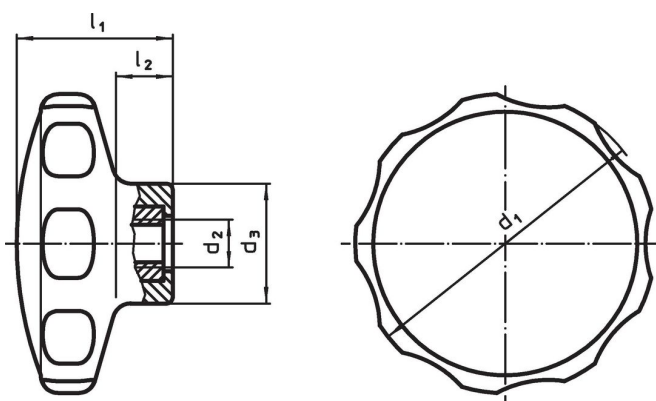

### Order information

Dimensions					min.	°C	max.	g	Art. No.
d <sub>1</sub>	d <sub>2</sub>	d <sub>3</sub> [mm]	l <sub>1</sub>	l <sub>2</sub>					
white									
62	M8	22	35	13	-30		80	30	24750.0061

### Compliance

#### RoHS compliant

Compliant according to Directive 2011/65/EU and Directive 2015/863.

#### Does not contain SVHC substances

No SVHC substances with more than 0.1% w/w contained - SVHC list [REACH] as of 23.01.2024.

#### Does not contain Proposition 65 substances

No Proposition 65 substances included.

<https://www.P65Warnings.ca.gov/>

#### Free from Conflict Minerals

This product does not contain any substances designated as "conflict minerals" such as tantalum, tin, gold or tungsten from the Democratic Republic of Congo or adjacent countries.