

## Palm Grip Screws • similar to DIN 6335, stainless steel A4

24731.0140



### Product Description

These grub screws with palm grip are manufactured according to DIN 6335, but it is a version without dirty edges. This makes these grub screws with palm grip suitable for all areas of application with high hygienic requirements. The stainless steel A4 version ensures maximum corrosion resistance.

### Material

#### Handle

- Stainless steel A4, polished

#### Screw

- Stainless steel A4

### Drawing

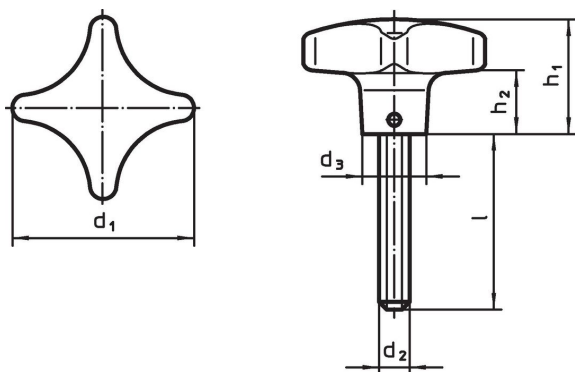

### Order information

Dimensions						[g]	Art. No.
d <sub>1</sub>	d <sub>2</sub>	l [mm]	d <sub>3</sub>	h <sub>1</sub>	h <sub>2</sub>		
50	M10	45	18	32	18	144	24731.0140

### Compliance

#### RoHS compliant

Compliant according to Directive 2011/65/EU and Directive 2015/863.

#### Does not contain SVHC substances

No SVHC substances with more than 0.1% w/w contained - SVHC list [REACH] as of 27.06.2024.

#### Does not contain Proposition 65 substances

No Proposition 65 substances included.

<https://www.P65Warnings.ca.gov/>

#### Free from Conflict Minerals

This product does not contain any substances designated as "conflict minerals" such as tantalum, tin, gold or tungsten from the Democratic Republic of Congo or adjacent countries.