

Palm Grips • DIN 6335 light metal

24630.0280



Product Description

These palm grips are manufactured according to DIN 6335.

Material

Handle

- Light metal Al, unpolished

Drawing

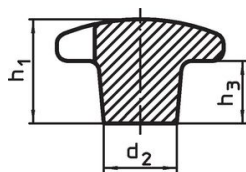

picture 1

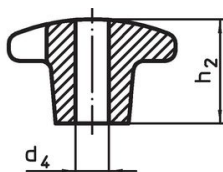

picture 2

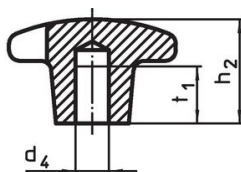

picture 3

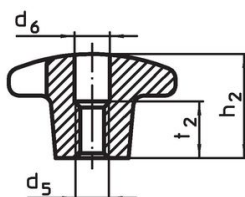
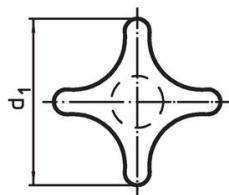

picture 4

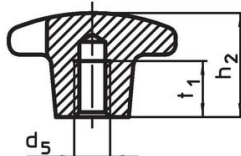

picture 5

Order information

d ₁	d ₂	Dimensions			[g]	Art. No.
		d ₄ H7 [mm]	h ₂	t ₁		
with smooth blind hole, form C – picture 3, unpolished						
80	25	16	50	28	138	24630.0280

Application example

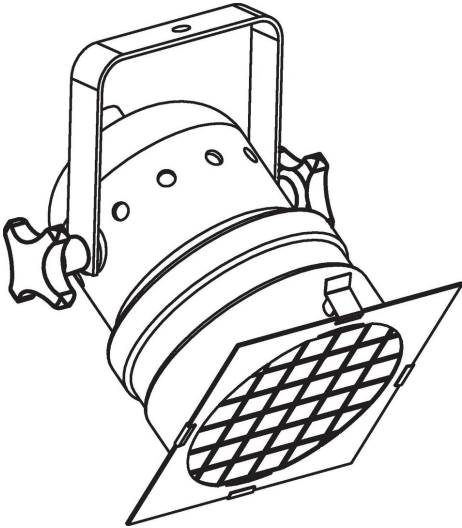

Compliance

RoHS compliant

Contains lead - compliant according to exceptions 6a / 6b / 6c.

Contains SVHC substances >0,1% w/w

Contains lead - SVHC list [REACH] as of 23.01.2024.

Contains Proposition 65 substances



Lead can cause cancer and reproductive harm from exposure
<https://www.P65Warnings.ca.gov/>

Free from Conflict Minerals

This product does not contain any substances designated as "conflict minerals" such as tantalum, tin, gold or tungsten from the Democratic Republic of Congo or adjacent countries.