

**Palm Grips • DIN 6335 grey cast iron, plastic-coated**  
24620.0663



**Product Description**

These palm grips are manufactured according to DIN 6335.

**Material**

**Handle**

- Grey cast iron GG 20, plastic-coated, black similar to RAL 9005

**Drawing**

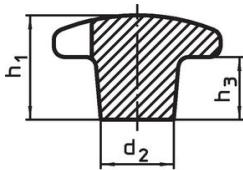

picture 1

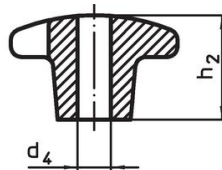

picture 2

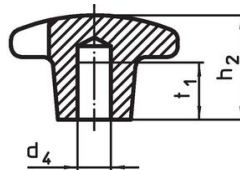

picture 3

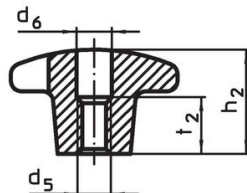
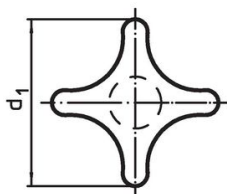

picture 4

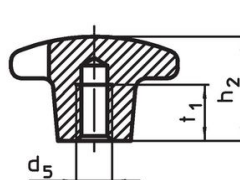

picture 5

**Order information**

d <sub>1</sub>	d <sub>2</sub>	Dimensions			[g]	Art. No.
		d <sub>4</sub> H7 [mm]	h <sub>2</sub>	t <sub>1</sub>		
with smooth blind hole, form C – picture 3, black						
63	20	12	40	22	201	24620.0663

**Application example**

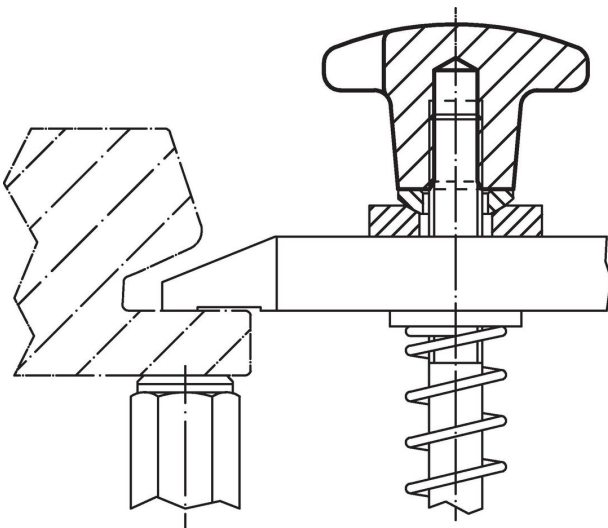

## Compliance

### RoHS compliant

Compliant according to Directive 2011/65/EU and Directive 2015/863.

### Does not contain SVHC substances

No SVHC substances with more than 0.1% w/w contained - SVHC list [REACH] as of 23.01.2024.

### Does not contain Proposition 65 substances

No Proposition 65 substances included.

<https://www.P65Warnings.ca.gov/>

### Free from Conflict Minerals

This product does not contain any substances designated as "conflict minerals" such as tantalum, tin, gold or tungsten from the Democratic Republic of Congo or adjacent countries.