

## Disc-Type Handwheels • DIN 3670

24570.0105



### Product Description

There are gripping indentations on the rear sides.  
Hub machined; rim turned and mirror-finished on all sides, non-machined surfaces cleanly blasted.

### Material

#### Handwheel

- Aluminium permanent-mould casting

### Assembly

Shaft-end washers EH 22270. for axial fastening.

### More information

### Further products

- Shaft-End Washers

### Drawing

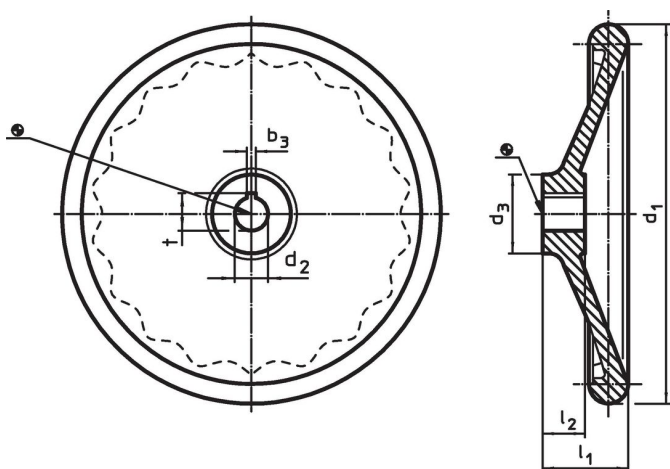

The orientation of the hub keyway may be different than shown in the drawing.

### Order information

d <sub>1</sub>	d <sub>2</sub> H7	Dimensions			[g]	Art. No.
		d <sub>3</sub> [mm]	l <sub>1</sub> ~	l <sub>2</sub>		
without steel bushing, form B, without hub keyway						
100	10	28	33	17	194	24570.0105

### Application example

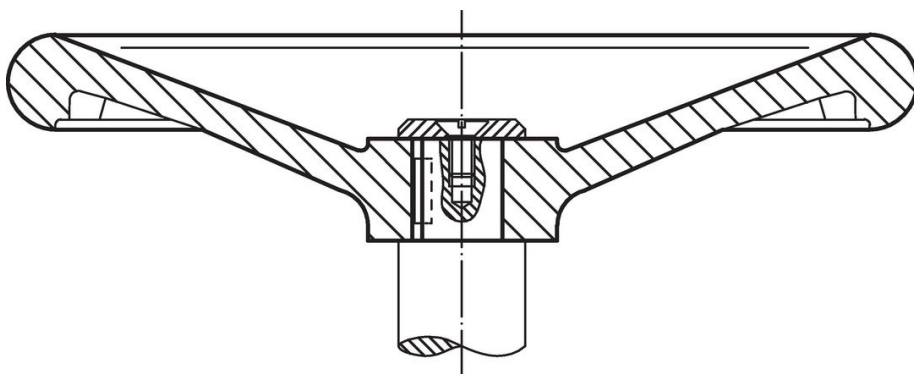

## Compliance

### RoHS compliant

Contains lead - compliant according to exceptions 6a / 6b / 6c.

### Contains SVHC substances >0,1% w/w

Contains lead - SVHC list [REACH] as of 23.01.2024.

### Contains Proposition 65 substances



Lead can cause cancer and reproductive harm from exposure

<https://www.P65Warnings.ca.gov/>

### Free from Conflict Minerals

This product does not contain any substances designated as "conflict minerals" such as tantalum, tin, gold or tungsten from the Democratic Republic of Congo or adjacent countries.