

Mushroom-Type Knobs

24540.0117



Product Description

Material

Mushroom-type knob

- Thermosetting plastic PF 31, black

Screw

- Steel, zinc-plated by galvanization

Drawing

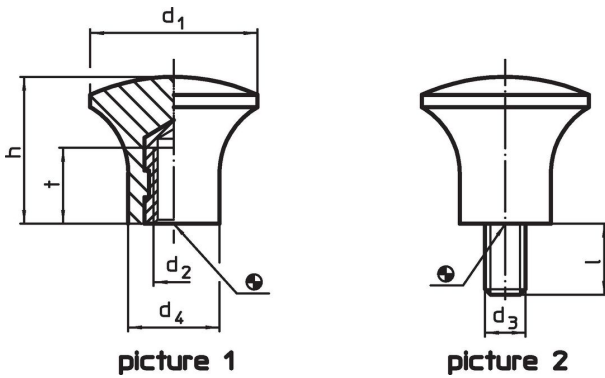

Order information

Dimensions					max. [°C]	[g]	Art. No.
d ₁	d ₃	l [mm]	d ₄	h			
with screw – picture 2							
17	M5	9	10	14	110	4.2	24540.0117

Application example

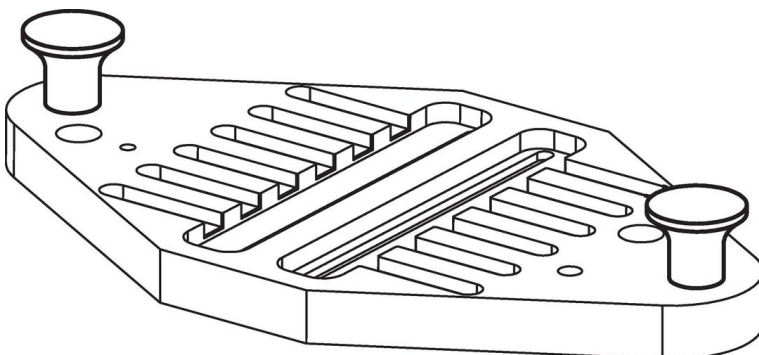

Compliance

RoHS compliant

Contains lead - compliant according to exceptions 6a / 6b / 6c.

Contains SVHC substances >0,1% w/w

Contains lead - SVHC list [REACH] as of 23.01.2024.

Contains Proposition 65 substances



Lead can cause cancer and reproductive harm from exposure
<https://www.P65Warnings.ca.gov/>

Free from Conflict Minerals

This product does not contain any substances designated as "conflict minerals" such as tantalum, tin, gold or tungsten from the Democratic Republic of Congo or adjacent countries.