

Tommy Nuts · DIN 6305 with fixed pin

24510.0512



Product Description

With this version, the pin is pressed in.

Material

- Free cutting steel, blackened

Drawing

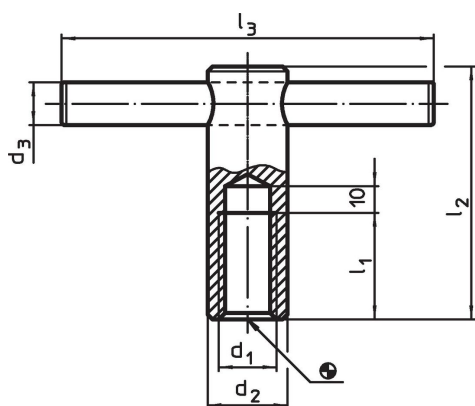

Order information

d ₁	d ₂	Dimensions				[g]	Art. No.
		d ₃	l ₁	l ₂	l ₃		
M12	20	10	25	70	100	192	24510.0512

Application example

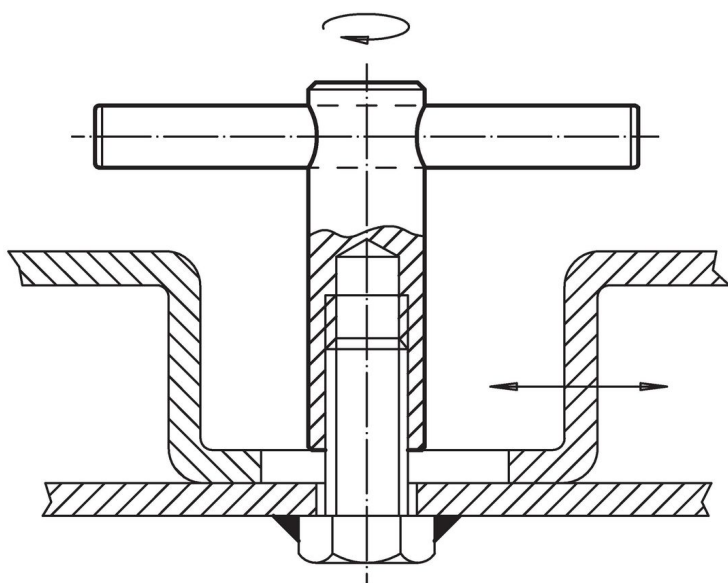

Compliance

RoHS compliant

Contains lead - compliant according to exceptions 6a / 6b / 6c.

Contains SVHC substances >0,1% w/w

Contains lead - SVHC list [REACH] as of 23.01.2024.

Contains Proposition 65 substances



Lead can cause cancer and reproductive harm from exposure
<https://www.P65Warnings.ca.gov/>

Free from Conflict Minerals

This product does not contain any substances designated as "conflict minerals" such as tantalum, tin, gold or tungsten from the Democratic Republic of Congo or adjacent countries.