

## Tommy Screws • DIN 6304 with fixed pin

24490.0013



### Product Description

With this version, the pin is pressed in.

### Material

- Free cutting steel, blackened, pressure lug hardened.

### More information

### References

Thrust point for thrust pad DIN 6311 form S, EH 22560.

### Further products

- Thrust Pads, DIN 6311 and low model

### Drawing

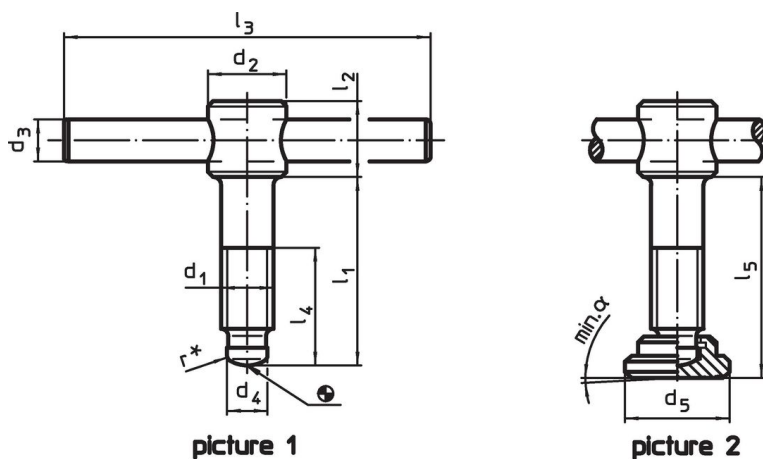

\* to ease assembly the DIN 6304 specification has been completed by r

### Order information

Dimensions								[g]	Art. No.
d <sub>1</sub>	l <sub>1</sub>	d <sub>2</sub>	d <sub>3</sub>	d <sub>4</sub>	l <sub>2</sub>	l <sub>3</sub>	l <sub>4</sub>		
without thrust pad, form E – picture 1									
M12	80	20	10	8	18	100	60	148	24490.0013

## Compliance

### RoHS compliant

Contains lead - compliant according to exceptions 6a / 6b / 6c.

### Contains SVHC substances >0,1% w/w

Contains lead - SVHC list [REACH] as of 23.01.2024.

### Contains Proposition 65 substances



Lead can cause cancer and reproductive harm from exposure  
<https://www.P65Warnings.ca.gov/>

### Free from Conflict Minerals

This product does not contain any substances designated as "conflict minerals" such as tantalum, tin, gold or tungsten from the Democratic Republic of Congo or adjacent countries.