

Knurled Nuts • DIN 6303

24480.0205



Product Description

Material

- Stainless steel 1.4305

Assembly

Form B: after being bored through the pin hole is to be situated within the tolerance field H7.

More information

Notes

Knurling pitch and knurling depth may differ from DIN.

Drawing

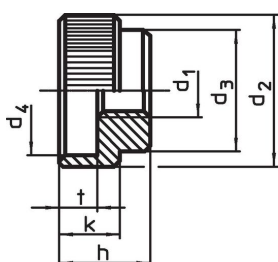

picture 1

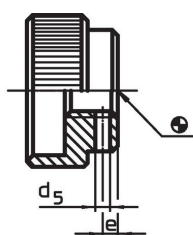

picture 2

Order information

Dimensions							[g]	Art. No.
d ₁	d ₂	d ₃	d ₄	h	k	t		
without pin hole, form A – picture 1, Stainless steel								
M5	20	14	15	12	8	5	16	24480.0205

Application example



Compliance

RoHS compliant

Compliant according to Directive 2011/65/EU and Directive 2015/863.

Does not contain SVHC substances

No SVHC substances with more than 0.1% w/w contained - SVHC list [REACH] as of 23.01.2024.

Does not contain Proposition 65 substances

No Proposition 65 substances included.

<https://www.P65Warnings.ca.gov/>

Free from Conflict Minerals

This product does not contain any substances designated as "conflict minerals" such as tantalum, tin, gold or tungsten from the Democratic Republic of Congo or adjacent countries.