

Tapered Levers • DIN 99

24470.0105



Product Description

Material

- Steel, blackened

Drawing

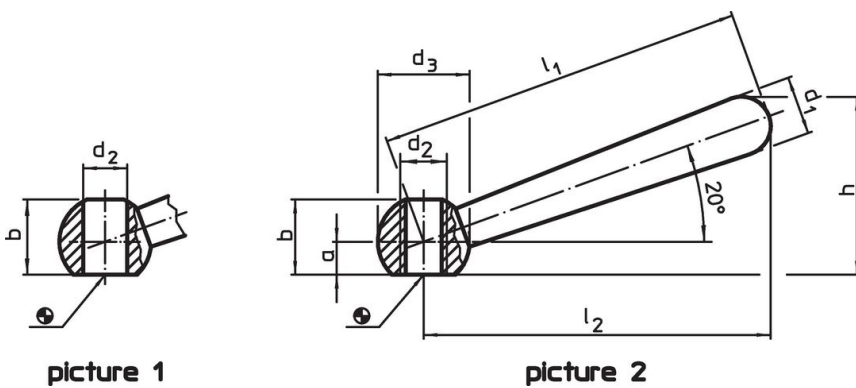

Order information

Dimensions								[g]	Art. No.
l_1	l_2 ~	a	b ~ [mm]	d_1	d_2 H7	d_3	h ~		
slanted, with smooth bore, form L – picture 1, Steel									
50	48	4	9.5	8	6	12	24	16	24470.0105

Application example



Compliance

RoHS compliant

Contains lead - compliant according to exceptions 6a / 6b / 6c.

Contains SVHC substances >0,1% w/w

Contains lead - SVHC list [REACH] as of 23.01.2024.

Contains Proposition 65 substances



Lead can cause cancer and reproductive harm from exposure
<https://www.P65Warnings.ca.gov/>

Free from Conflict Minerals

This product does not contain any substances designated as "conflict minerals" such as tantalum, tin, gold or tungsten from the Democratic Republic of Congo or adjacent countries.