

## Rotating Machine Handles • DIN 98

24460.0020



### Product Description

#### Material

- Steel, turned, zinc-plated by galvanization, passivated

### Drawing

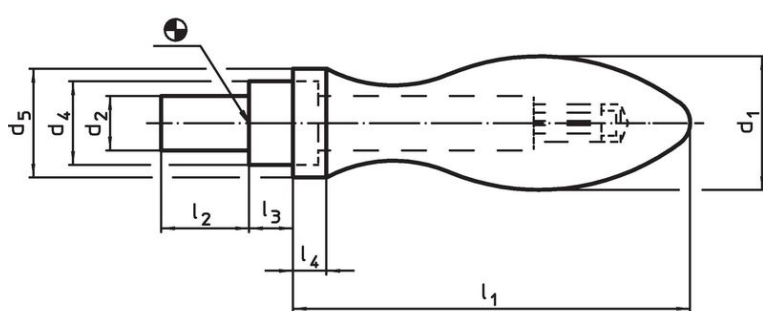

picture 1

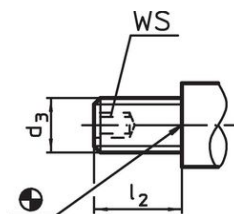

picture 2

### Order information

Dimensions								[g]	Art. No.
d <sub>1</sub>	d <sub>2</sub> h8	d <sub>4</sub> h13	d <sub>5</sub>	l <sub>1</sub> ~	l <sub>2</sub>	l <sub>3</sub>	l <sub>4</sub>		
with smooth lug, form D – picture 1									
20	8	13	18	61	13	6	6	109	24460.0020

### Application example

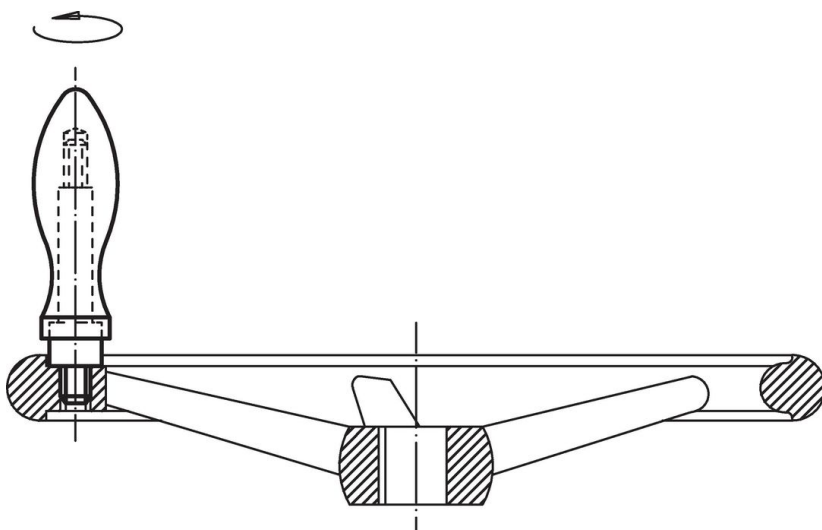

## Compliance

### RoHS compliant

Contains lead - compliant according to exceptions 6a / 6b / 6c.

### Contains SVHC substances >0,1% w/w

Contains lead - SVHC list [REACH] as of 27.06.2024.

### Contains Proposition 65 substances



Lead can cause cancer and reproductive harm from exposure

<https://www.P65Warnings.ca.gov/>

### Free from Conflict Minerals

This product does not contain any substances designated as "conflict minerals" such as tantalum, tin, gold or tungsten from the Democratic Republic of Congo or adjacent countries.