

Adjustable Flat Tension Levers • with screw

24441.0925



Product Description

Adjustable flat tension levers are used when the swivel range is limited or a specific lever position is required.

Adjustable flat tension levers are characterised by their low construction height and are particularly suitable for use in restricted spaces or when the lever should not overhang..

Material

Lever

- Zinc die-cast, plastic coated, silver, similar to RAL 9006, matt structure

Inner parts

- Steel, blackened

Screw

- Steel, blackened

Covering

- Plastic, light grey

Operation

By lifting the lever the serrations are disengaged. The lever can be positioned by the serrations. On releasing the lever, the serrations are automatically re-engaged.

Drawing



Order information

Dimensions										Temperature		Weight	Art. No.
d ₁	d ₂	l ₁	d ₃	h ₁	h ₂	h ₃	h ₄	l ₂	min.	max.	[g]		
[mm]										[°C]			
silver													
40	M12	32	23	42	4	4	56	145	-30	80	440	24441.0925	

Application example

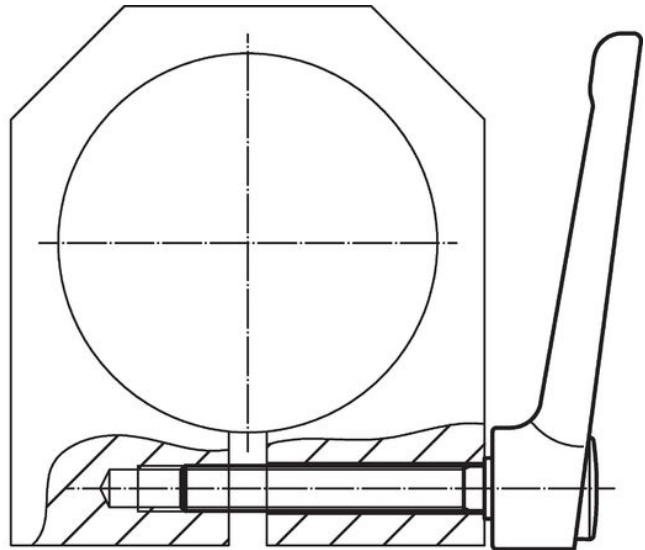

Compliance

RoHS compliant

Contains lead - compliant according to exceptions 6a / 6b / 6c.

Contains SVHC substances >0,1% w/w

Contains lead - SVHC list [REACH] as of 27.06.2024.

Contains Proposition 65 substances



Lead can cause cancer and reproductive harm from exposure
<https://www.P65Warnings.ca.gov/>

Free from Conflict Minerals

This product does not contain any substances designated as "conflict minerals" such as tantalum, tin, gold or tungsten from the Democratic Republic of Congo or adjacent countries.