

## Tension Levers

24430.0248



### Product Description

#### Material

##### Lever

- Stainless steel 1.4305, dull blasted

##### Ball knob

- Thermosetting plastic PF 31, black, DIN 319

### Drawing

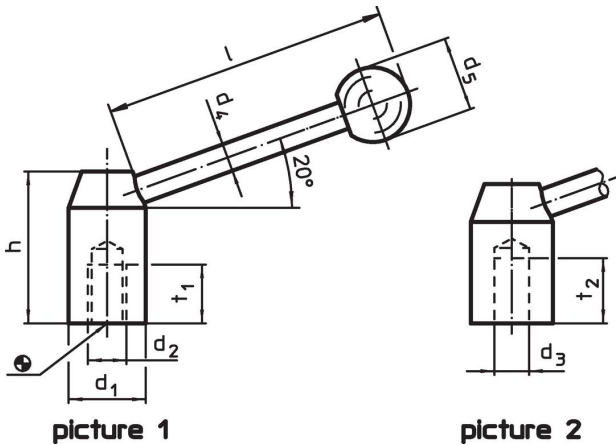

### Order information

d <sub>1</sub>	d <sub>2</sub>	d <sub>4</sub>	Dimensions				t <sub>1</sub>	[g]	Art. No.
			d <sub>5</sub>	h	l	~			
with female thread – picture 1, Stainless steel									
32	M16	12	32	52	126	23	354	24430.0248	

### Application example

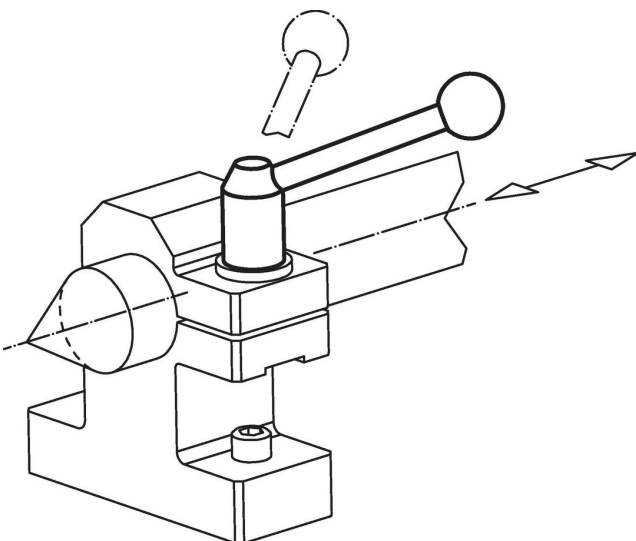

## Compliance

### RoHS compliant

Compliant according to Directive 2011/65/EU and Directive 2015/863.

### Does not contain SVHC substances

No SVHC substances with more than 0.1% w/w contained - SVHC list [REACH] as of 27.06.2024.

### Does not contain Proposition 65 substances

No Proposition 65 substances included.

<https://www.P65Warnings.ca.gov/>

### Free from Conflict Minerals

This product does not contain any substances designated as "conflict minerals" such as tantalum, tin, gold or tungsten from the Democratic Republic of Congo or adjacent countries.