

Tension Levers

24430.0045



Product Description

Material

Lever

- Steel, blackened

Ball knob

- Thermosetting plastic PF 31, black, DIN 319

Drawing

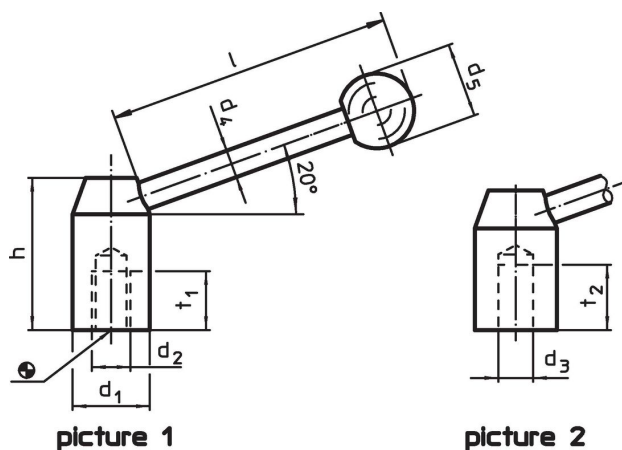

Order information

Dimensions							[g]	Art. No.
d ₁	d ₃ H7	d ₄	d ₅ [mm]	h	l ~	t ₂		
with smooth bore – picture 2, Steel								
32	16	12	32	52	126	28	351	24430.0045

Application example

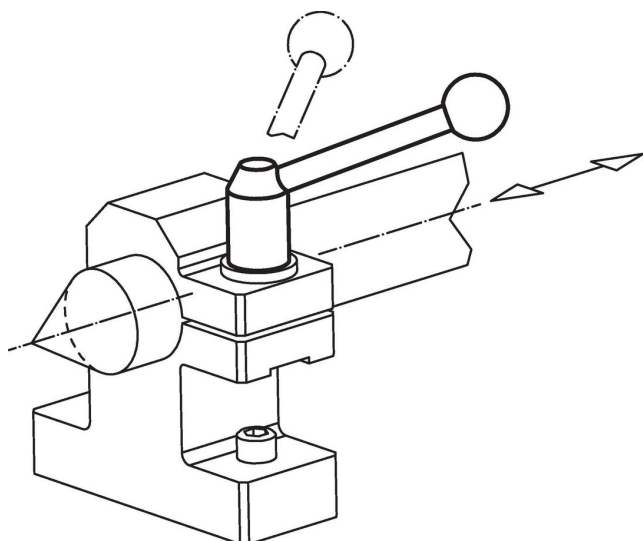

Compliance

RoHS compliant

Contains lead - compliant according to exceptions 6a / 6b / 6c.

Contains SVHC substances >0,1% w/w

Contains lead - SVHC list [REACH] as of 27.06.2024.

Contains Proposition 65 substances



Lead can cause cancer and reproductive harm from exposure
<https://www.P65Warnings.ca.gov/>

Free from Conflict Minerals

This product does not contain any substances designated as "conflict minerals" such as tantalum, tin, gold or tungsten from the Democratic Republic of Congo or adjacent countries.