

## Adjustable Clamping Levers · with axial bearing from stainless steel, with screw

24420.1050



### Product Description

Adjustable clamping levers with rust-proof inner parts. Suitable for multiple applications, e.g. medical environments, chemical industry, and so on.

Advantages of axial bearing:

- Double clamping force with same lever size, by reducing the surface friction.
- Protection of workpiece by a fixed locating surface.
- Little setting due to higher pre-clamping force of bolt, e.g. thread.

### Material

#### Lever

- Zinc die-cast, plastic coated, orange similar to RAL 2004, matt structure

#### Inner parts

- Stainless steel

#### Screw

- Stainless steel

### Operation

**By lifting the lever** the serrations are disengaged. The lever can be positioned by the serrations. On releasing the lever, the serrations are automatically re-engaged.

### Drawing

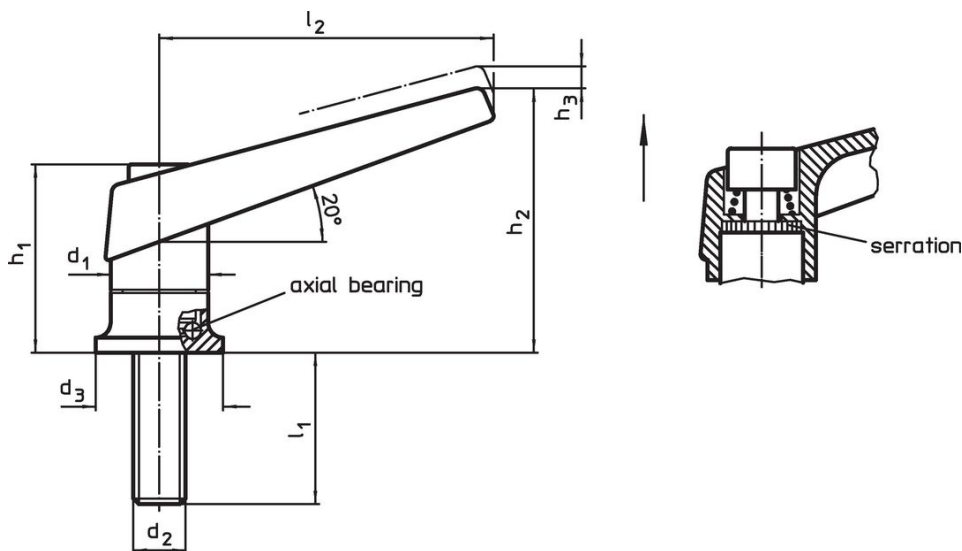

### Order information

Dimensions									Art. No.
$d_1$	$d_2$	$l_1$	$d_3$	$h_1$	$h_2$	$h_3$	$l_2$	[g]	
orange									
18	M6	27	24	34.5	50	3	62	99	24420.1050

Application example

Increase of clamping force with axial bearing  
(while manual force is unchanged)

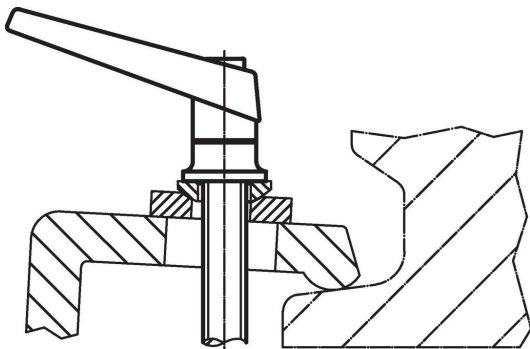

Compliance

RoHS compliant

Contains lead - compliant according to exceptions 6a / 6b / 6c.

Contains SVHC substances >0,1% w/w

Contains lead - SVHC list [REACH] as of 23.01.2024.

Contains Proposition 65 substances



Lead can cause cancer and reproductive harm from exposure  
<https://www.P65Warnings.ca.gov/>

Free from Conflict Minerals

This product does not contain any substances designated as "conflict minerals" such as tantalum, tin, gold or tungsten from the Democratic Republic of Congo or adjacent countries.