

## Gear Lever Handles

24350.0130



### Product Description

#### Material

##### Gear lever handle

- Steel, zinc-plated by galvanization, passivated

##### Ball knob

- Thermosetting plastic PF 31, black, DIN 319

##### Cylindrical handle

- Thermosetting plastic PF 31, black

### Drawing

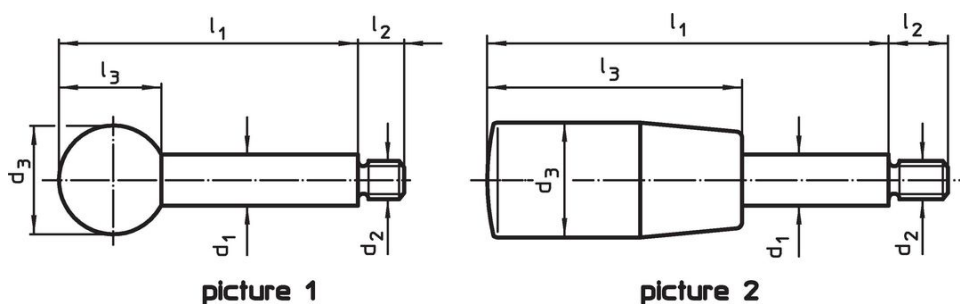

### Order information

Dimensions						max. [°C]	[g]	Art. No.
d <sub>1</sub>	l <sub>1</sub>	d <sub>2</sub>	d <sub>3</sub>	l <sub>2</sub>	l <sub>3</sub>			
with cylindrical handle – picture 2, Steel								
10	80	M8	21	11	50	110	50	24350.0130

## Application example



## Compliance

### RoHS compliant

Compliant according to Directive 2011/65/EU and Directive 2015/863.

### Does not contain SVHC substances

No SVHC substances with more than 0.1% w/w contained - SVHC list [REACH] as of 27.06.2024.

### Does not contain Proposition 65 substances

No Proposition 65 substances included.

<https://www.P65Warnings.ca.gov/>

### Free from Conflict Minerals

This product does not contain any substances designated as "conflict minerals" such as tantalum, tin, gold or tungsten from the Democratic Republic of Congo or adjacent countries.