

Crank Handles

24330.0420



Product Description

Material

Handle body

- Zinc die-cast, plastic coated, black, matt structure

Cylindrical handle

- Thermosetting plastic PF 31, black

More information

References

Alternative to crank handles DIN 469.

Drawing

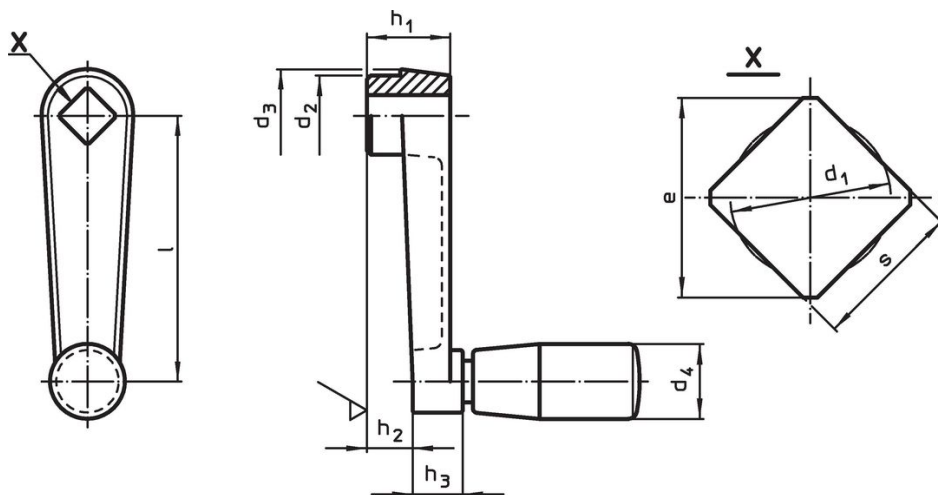

Order information

Dimensions									d_4	🌡️	📦	Art. No.
l	s H11	e min.	d_1 max.	d_2	d_3	h_1	h_2 ~	h_3	Cylindrical handle Ø EH 24530.	max.		
[mm]									[mm]	[°C]	[g]	
Zinc die-cast												
50	8	10.1	8.4	16	18	18	10	10	14	80	58	24330.0420

Application example

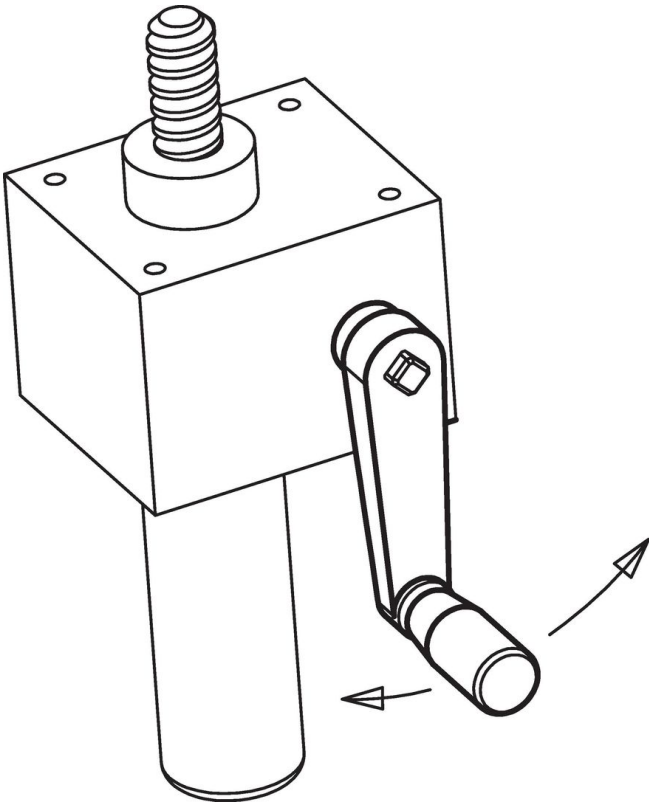

Compliance

RoHS compliant

Contains lead - compliant according to exceptions 6a / 6b / 6c.

Contains SVHC substances >0,1% w/w

Contains lead - SVHC list [REACH] as of 27.06.2024.

Contains Proposition 65 substances



Lead can cause cancer and reproductive harm from exposure
<https://www.P65Warnings.ca.gov/>

Free from Conflict Minerals

This product does not contain any substances designated as "conflict minerals" such as tantalum, tin, gold or tungsten from the Democratic Republic of Congo or adjacent countries.