

Crank Handles · DIN 469 straight with square end DIN 79
24330.0060



Product Description

With these crank handles, the seam is ground and blasted. The hub is machined.

Material

Machine handle

- Steel, turned, zinc-plated by galvanization, passivated

Handle body

- Nodular cast iron, plastic coated, black

Drawing

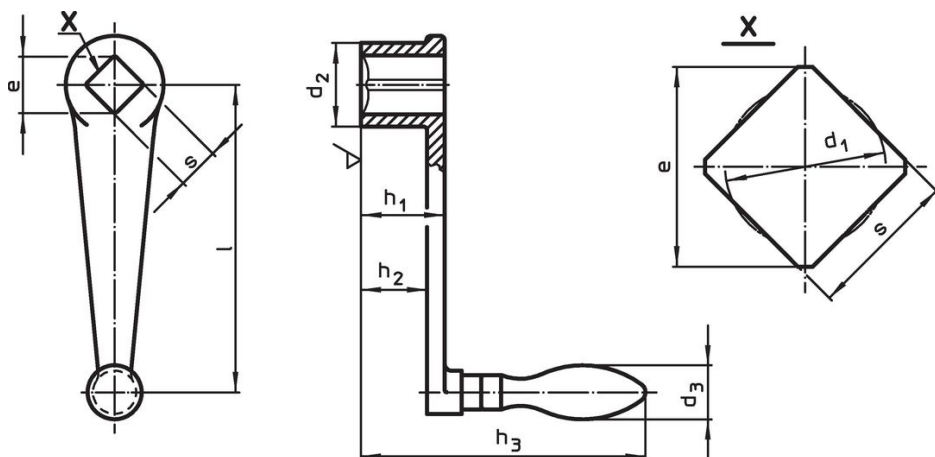

Order information

l	s H11	e min.	Dimensions					d ₃ Machine handle Ø	[g]	Art. No.
			d ₁	d ₂	h ₁	h ₂	h ₃			
with rotating machine handle (EH 24460., DIN 98), form D										
200	19	25.2	20	44	44	34	160	28	1054	24330.0060

Compliance

RoHS compliant

Contains lead - compliant according to exceptions 6a / 6b / 6c.

Contains SVHC substances >0,1% w/w

Contains lead - SVHC list [REACH] as of 23.01.2024.

Contains Proposition 65 substances



Lead can cause cancer and reproductive harm from exposure
<https://www.P65Warnings.ca.gov/>

Free from Conflict Minerals

This product does not contain any substances designated as "conflict minerals" such as tantalum, tin, gold or tungsten from the Democratic Republic of Congo or adjacent countries.