

U-Handles • plastic, front mounting

24320.0040



Product Description

U-handles are used, for example, on machine doors, furniture doors, cabinet doors, drawers and drawer units.

These U-handles made of glass fibre reinforced plastic are characterised by their ergonomic and stable construction and their simple and timeless design.

Material

Handle

- Thermoplastic PA, glass-fibre reinforced, black

Assembly

Mounting is done from the operating side by means of a cylinder screw.

Drawing

For for cylinder head stud
ISO4762 – M6/M8/M10

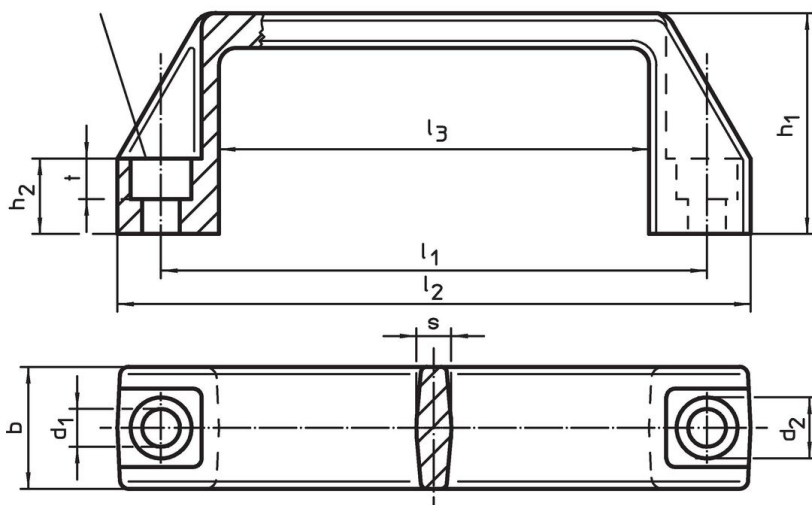

Order information

Dimensions										For cylinder screw	🌡️ max.	📦 [g]	Art. No.
l_1 ±0.5	d_1	b	l_2	d_2	h_1	h_2	l_3	s	t	[mm]	[°C]	[g]	
179	8.5	28	196	13.5	50	17	151	7.5	8.5	M8	100	70	24320.0040

Application example

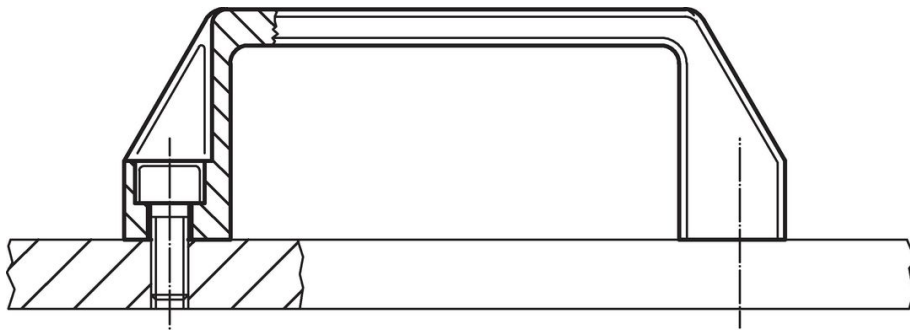

Compliance

RoHS compliant

Compliant according to Directive 2011/65/EU and Directive 2015/863.

Does not contain SVHC substances

No SVHC substances with more than 0.1% w/w contained - SVHC list [REACH] as of 23.01.2024.

Does not contain Proposition 65 substances

No Proposition 65 substances included.

<https://www.P65Warnings.ca.gov/>

Free from Conflict Minerals

This product does not contain any substances designated as "conflict minerals" such as tantalum, tin, gold or tungsten from the Democratic Republic of Congo or adjacent countries.